

FG

Standardised "EN 733" centrifugal pumps

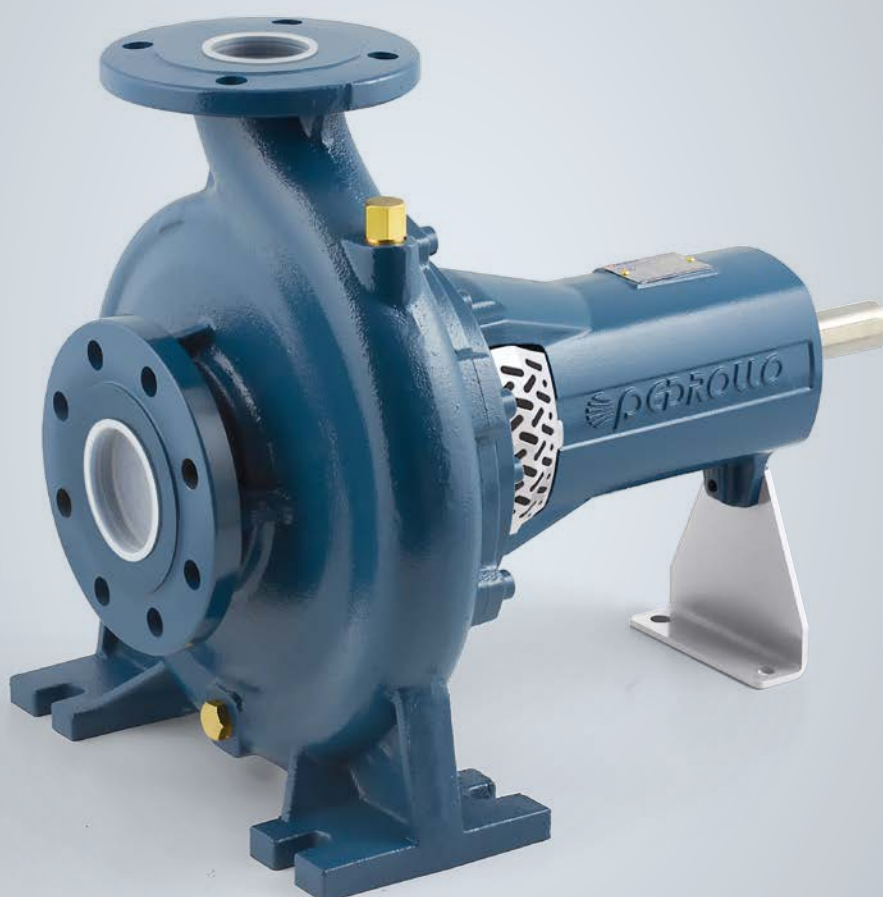

CHARACTERISTIC CURVES

n = 2900 1/min 2 Pole 50 Hz

 **PEDROLLO**[®]
... the spring of life

PERFORMANCE RANGE

n= 2900 1/min 2 Pole 50 Hz HS= 0 m

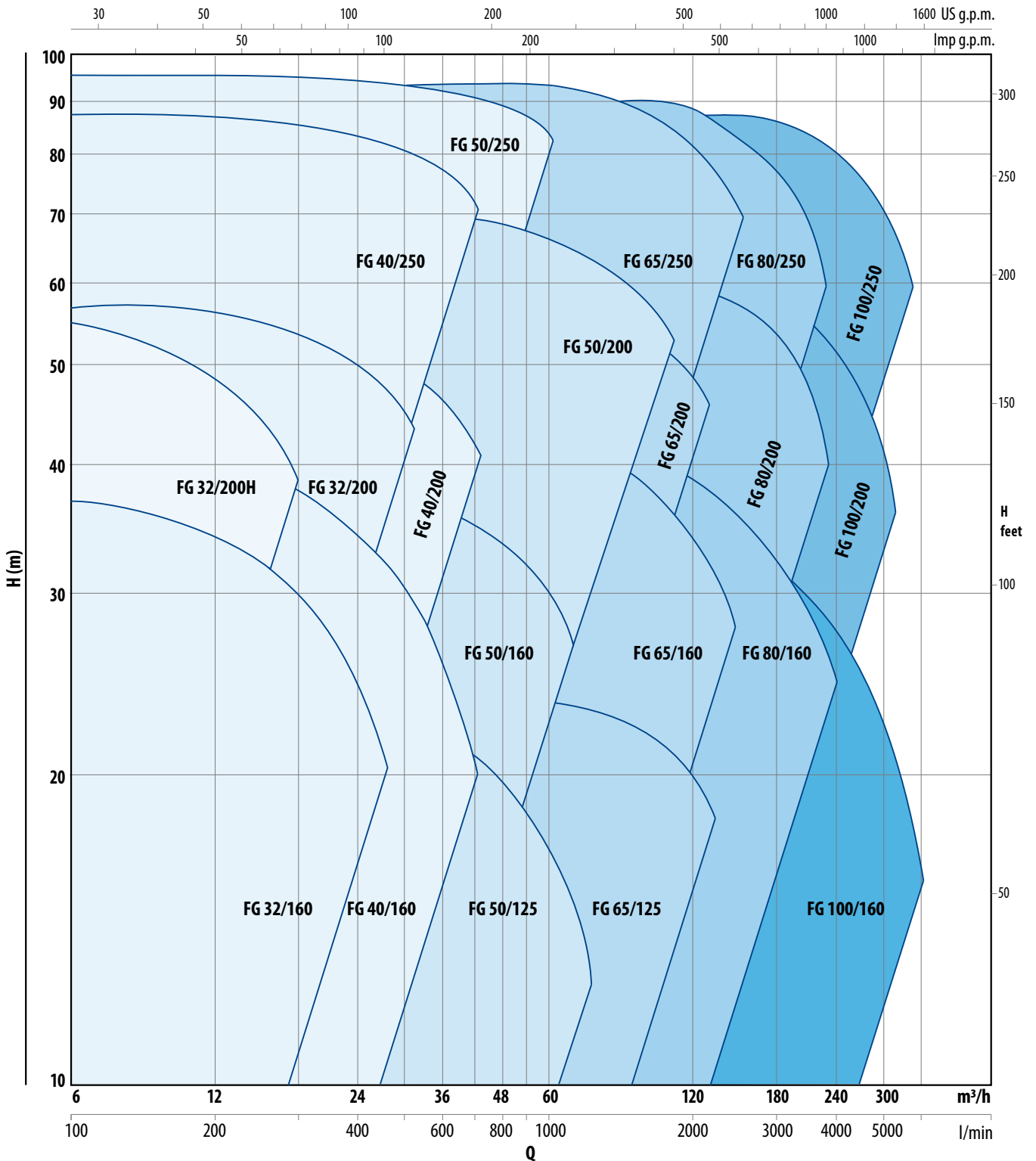

- Hydraulic performance and connection dimensions compliant with standard EN 733.
- REGULATION (EU) N. 547/2012
- The declared performances are valid for liquids with density 1000 kg/m³, kinematic viscosity 1 mm²/s and water temperature 15 °C.
- Tolerance of characteristic curves in compliance with EN ISO 9906 Grado 3.

PERFORMANCE DATA
n=2900 1/min 2 Pole 50 Hz HS= 0 m

MODEL pump	MOTOR PAIRING		PERFORMANCE	
	kW	HP	Q m ³ /h	H metres
FG 32/160C	1.5	2	6 ÷ 21	24 ÷ 14
FG 32/160B	2.2	3	6 ÷ 24	30 ÷ 17
FG 32/160A	3	4	6 ÷ 27	37 ÷ 24
FG 32/200C	4	5.5	6 ÷ 27	44 ÷ 31.5
FG 32/200B	5.5	7.5	6 ÷ 30	51 ÷ 36
FG 32/200A	7.5	10	6 ÷ 30	57 ÷ 44
FG 32/200BH	3	4	6 ÷ 18	45 ÷ 37
FG 32/200AH	4	5.5	6 ÷ 19.2	55 ÷ 44
FG 40/160C	2.2	3	6 ÷ 36	27 ÷ 14
FG 40/160B	3	4	6 ÷ 36	32 ÷ 20
FG 40/160A	4	5.5	6 ÷ 42	38 ÷ 20
FG 40/200B	5.5	7.5	6 ÷ 42	47 ÷ 28
FG 40/200A	7.5	10	6 ÷ 42	55 ÷ 41
FG 40/250C	9.2	12.5	6 ÷ 42	64 ÷ 47
FG 40/250B	11	15	6 ÷ 42	71 ÷ 55
FG 40/250A	15	20	6 ÷ 42	88 ÷ 72
FG 50/125C	2.2	3	18 ÷ 72	17.5 ÷ 6
FG 50/125B	3	4	18 ÷ 72	20.7 ÷ 9
FG 50/125A	4	5.5	18 ÷ 72	23.5 ÷ 13
FG 50/160C	4	5.5	18 ÷ 60	27 ÷ 16
FG 50/160B	5.5	7.5	18 ÷ 66	32 ÷ 21
FG 50/160A	7.5	10	18 ÷ 66	37 ÷ 27
FG 50/200C	11	15	24 ÷ 102	44 ÷ 30
FG 50/200B	15	20	24 ÷ 102	52 ÷ 38
FG 50/200A	18.5	25	24 ÷ 108	61 ÷ 45
FG 50/200AR	22	30	24 ÷ 108	69 ÷ 53
FG 50/250D	9.2	12.5	18 ÷ 54	51 ÷ 32
FG 50/250C	11	15	18 ÷ 54	59 ÷ 42
FG 50/250B	15	20	18 ÷ 60	72 ÷ 59
FG 50/250A	18.5	25	18 ÷ 60	85 ÷ 73
FG 50/250AR	22	30	18 ÷ 60	95 ÷ 83
FG 65/125C	4	5.5	36 ÷ 108	16 ÷ 11
FG 65/125B	5.5	7.5	36 ÷ 120	18 ÷ 13
FG 65/125A	7.5	10	36 ÷ 132	23 ÷ 18
FG 65/160C	9.2	12.5	36 ÷ 132	32 ÷ 22
FG 65/160B	11	15	36 ÷ 144	36.5 ÷ 23
FG 65/160A	15	20	36 ÷ 144	40.5 ÷ 28
FG 65/200B	15	20	24 ÷ 120	45 ÷ 35.5
FG 65/200A	18.5	25	24 ÷ 126	51 ÷ 40
FG 65/200AR	22	30	24 ÷ 126	57 ÷ 46
FG 65/250C	30	40	24 ÷ 141	76 ÷ 53
FG 65/250B	37	50	24 ÷ 150	87 ÷ 62
FG 65/250A	45	60	24 ÷ 156	94.5 ÷ 68

MODEL pump	MOTOR PAIRING		PERFORMANCE	
	kW	HP	Q m ³ /h	H metres
FG 80/160D	11	15	30 ÷ 240	25 ÷ 10
FG 80/160C	15	20	30 ÷ 240	30 ÷ 15
FG 80/160B	18.5	25	30 ÷ 240	35 ÷ 20
FG 80/160A	22	30	30 ÷ 240	40 ÷ 25
FG 80/200B	30	40	30 ÷ 219	56 ÷ 34.5
FG 80/200A	37	50	30 ÷ 234	62 ÷ 40
FG 80/250B	45	60	36 ÷ 216	77 ÷ 54
FG 80/250A	55	75	36 ÷ 234	88.5 ÷ 60
FG 100/160C	15	20	60 ÷ 300	28 ÷ 12
FG 100/160B	18.5	25	60 ÷ 330	32 ÷ 13
FG 100/160A	22	30	60 ÷ 360	35 ÷ 15
FG 100/200C	30	40	48 ÷ 279	51 ÷ 28
FG 100/200B	37	50	48 ÷ 294	57 ÷ 33
FG 100/200A	45	60	48 ÷ 315	63 ÷ 38
FG 100/250B	55	75	48 ÷ 309	75 ÷ 48
FG 100/250A	75	100	48 ÷ 345	89 ÷ 58

DIMENSIONS AND WEIGHT

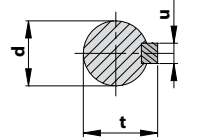
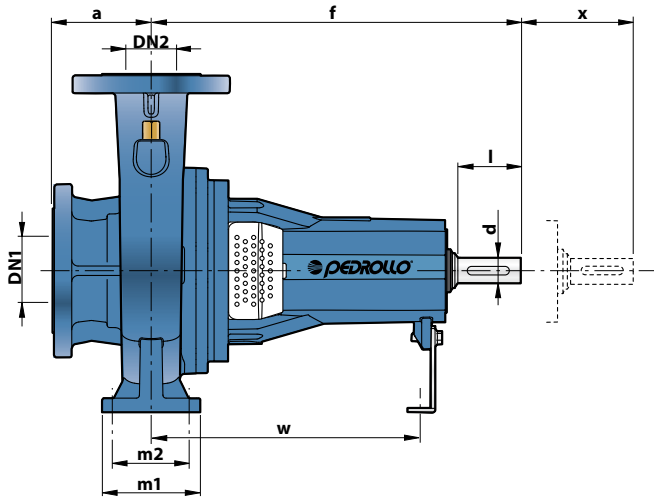

SHAFT DIMENSIONS		
mm		
d	u	t
24 k6	8	27
32 k6	10	35

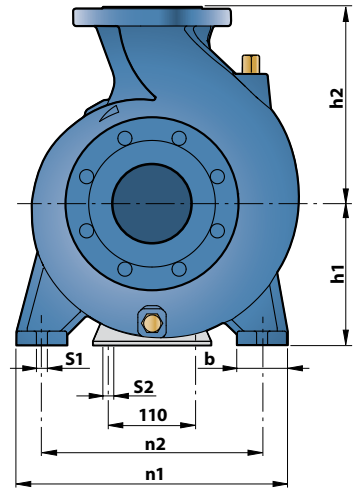

DN FLANGES	D mm	K mm	HOLES	
			N°	Ø (mm)
32	140	100	4	18
40	150	110		
50	165	125		
65	185	145		
80	200	160	8	18
100	220	180		
125	250	210		

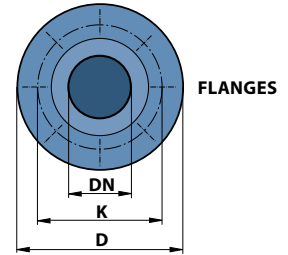

MODEL	PORTS		DIMENSIONS mm														kg				
	DN1	DN2	a	f	h1	h2	b	m1	m2	n1	n2	s1	s2	w	x	d		l			
FG 32/160	50	32	80	360	132	160	50	100	70	240	190	14	14	260	100	24	50	32			
FG 32/200					160	180	55	95		245	35										
FG 32/200H					160	180	55	100	240	35											
FG 40/160	65	40	100	360	132	160	50	100	70	240		14	14	260	100	24	50	35			
FG 40/200					160	180	55	100		265	212							38			
FG 40/250					180	225	65	125	95	320	250							58			
FG 50/125	65	50	100	360	132	160	50	100	70	240	190	14	14	260	100	24	50	30			
FG 50/160					160	180	55	100		265	212							35			
FG 50/200					160	200	50											45			
FG 50/250					180	225	65			320	250							50			
FG 65/125	80	65	100	360	160	180	65	125	95	280	212	14	14	260	100	24	50	42			
FG 65/160					160	200	65	125										45			
FG 65/200					180	225	65		320	250	50										
FG 65/250				470	200	250	80	160	120	360	280	18		340		32	80	71			
FG 80/160	100	80	125	470	360	180	225	65	125	95	320	250	14		260		24	50	48		
FG 80/200					180	250	65			345	280					340	140	32	80	65	
FG 80/250					200	280	80			400	315										79
FG 100/160	125	100	140	470	360	200	280	80	160	120	360	280	18		260		24	50	55		
FG 100/200					200	280	80			360	280										75
FG 100/250					225	280	80			400	315							340		32	80

IMPELLERS TRIMMING

To reduce the performances of radial or semi-axial pumps, at the same speed of rotation, the outside diameter of the impeller should be reduced.

The trimming should be limited to the value where the impeller blades still overlap when we look at them radially.

The diagrams of pump characteristics usually show curves for several impeller diameters

To calculate the diameter reduction a rule of thumb can be applied; an exact calculation is not possible since the geometric similarity of the impeller blades is not preserved when trimming the impeller.

The impellers with conic exit width are trimmed on the blades as shown in the characteristic curves diagrams (as shown in Fig. 1).

The relationship between Q and H and the outside diameter (average if required) of the impeller is resumed in the following approximate equation (index 1=condition prior to the reduction in diameter, index 2=condition after reduction)

$$(\varnothing_1/\varnothing_2)^2 \approx Q_1/Q_2 \approx H_1/H_2 \quad \text{Equation (1)}$$

There follows:

$$\varnothing_2 \approx \varnothing_1 \cdot \sqrt{(Q_2/Q_1)} \approx \varnothing_1 \cdot \sqrt{(H_2/H_1)} \quad \text{Equation (2)}$$

The parameters required to determine the reduced diameter are found as shown in fig. 2.

After identifying the new P2 working point in the performance chart, draw a straight line between the origin (Q = 0 and H = 0) and this point to intersect at a P1 point the available performance curve at diameter \varnothing_1 .

Therefore the values Q and H with index 1 and 2 can be found and then used with Equation 2 to determine the new trimming diameter \varnothing_2 .

CAREFUL: after turning down impeller, calculate the new input power using the following equation

$$N = (Q \cdot H \cdot \gamma) / (367 \cdot \eta / 100)$$

Nomenclature:

N = power in kW

Q = flow rate in m³/h

H = total head in m

γ = density in kg/dm³

η = pump efficiency

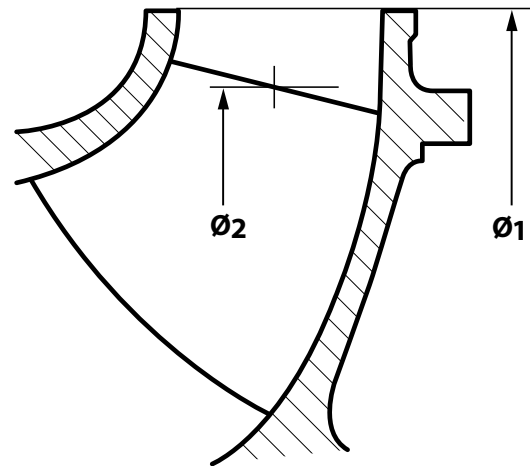

Fig. 1: Contour for cutting back the vanes of an impeller with a mixed flow exit

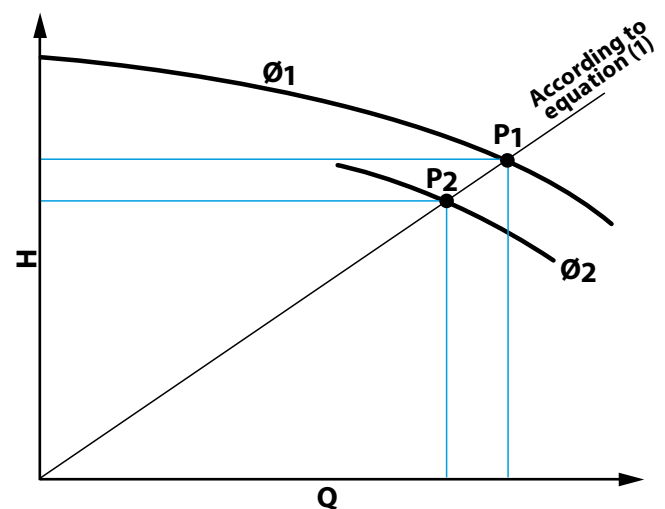
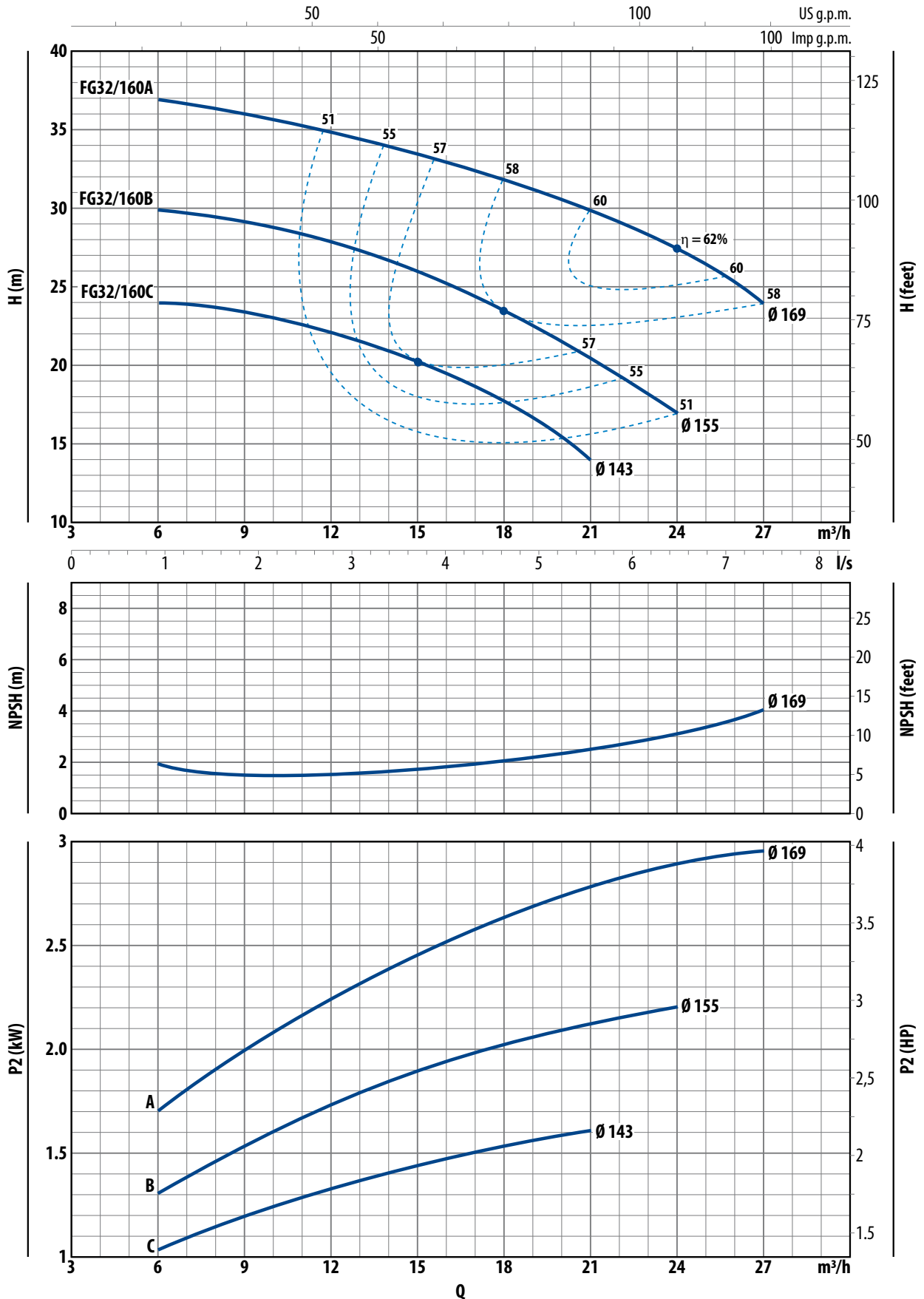

Fig. 2: Determination of the reduced impeller diameter \varnothing_2

FG32/160

CHARACTERISTIC CURVES

n= 2900 1/min 2 Pole 50 Hz HS= 0 m



CHARACTERISTIC CURVES

n= 2900 1/min 2 Pole 50 Hz HS= 0 m

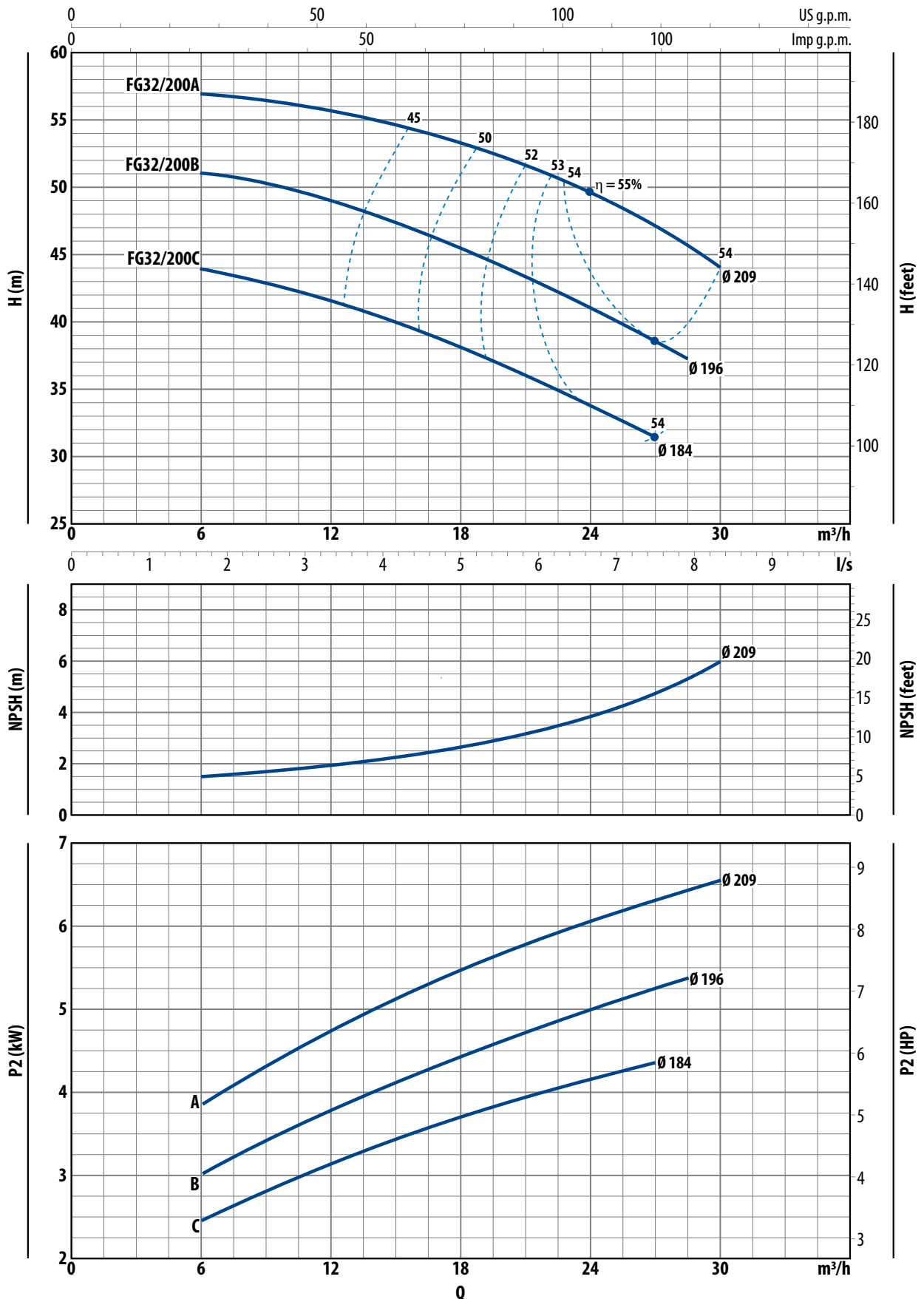

FG32/200H

CHARACTERISTIC CURVES

n= 2900 1/min 2 Pole 50 Hz HS= 0 m

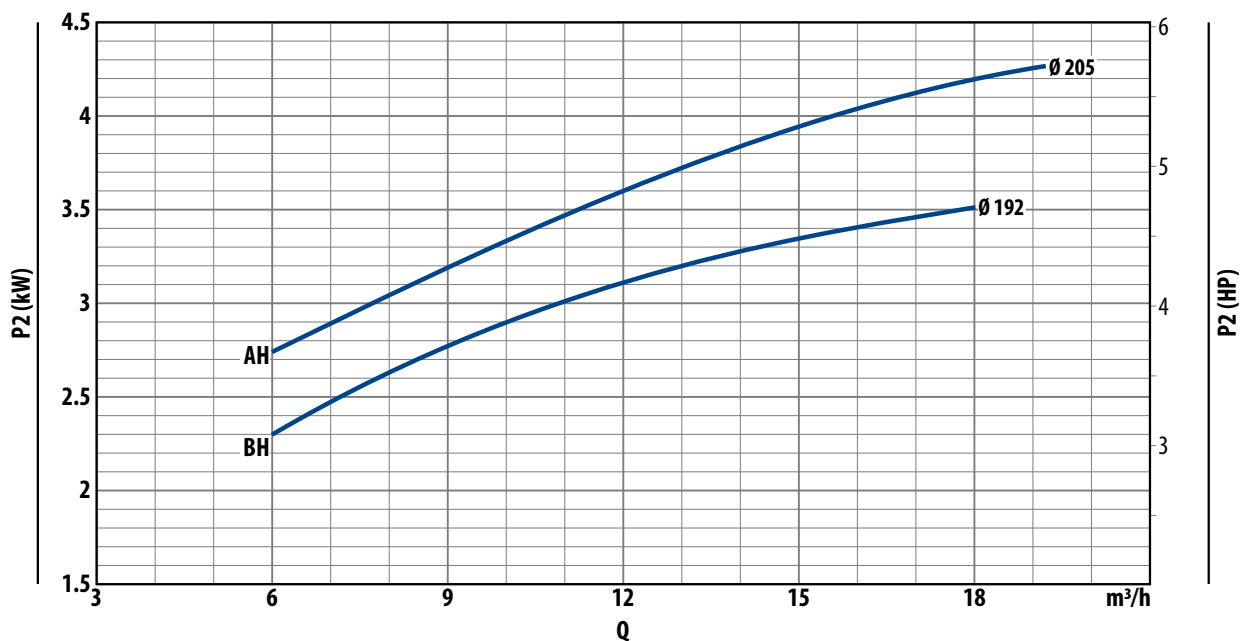
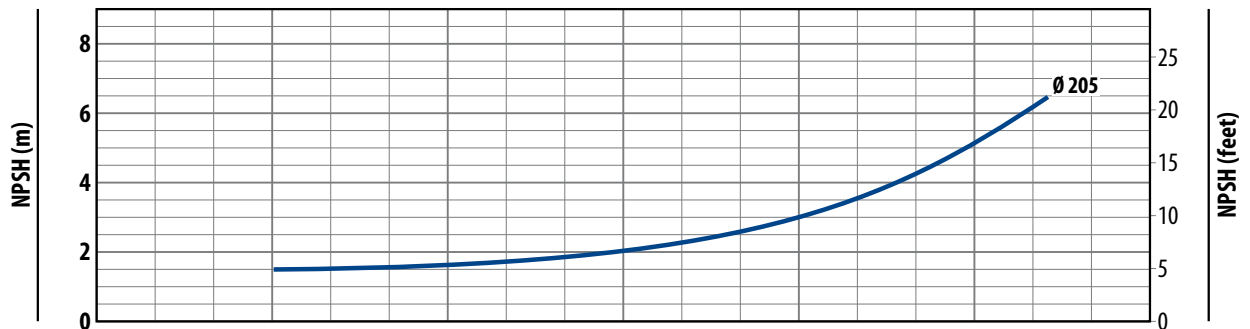
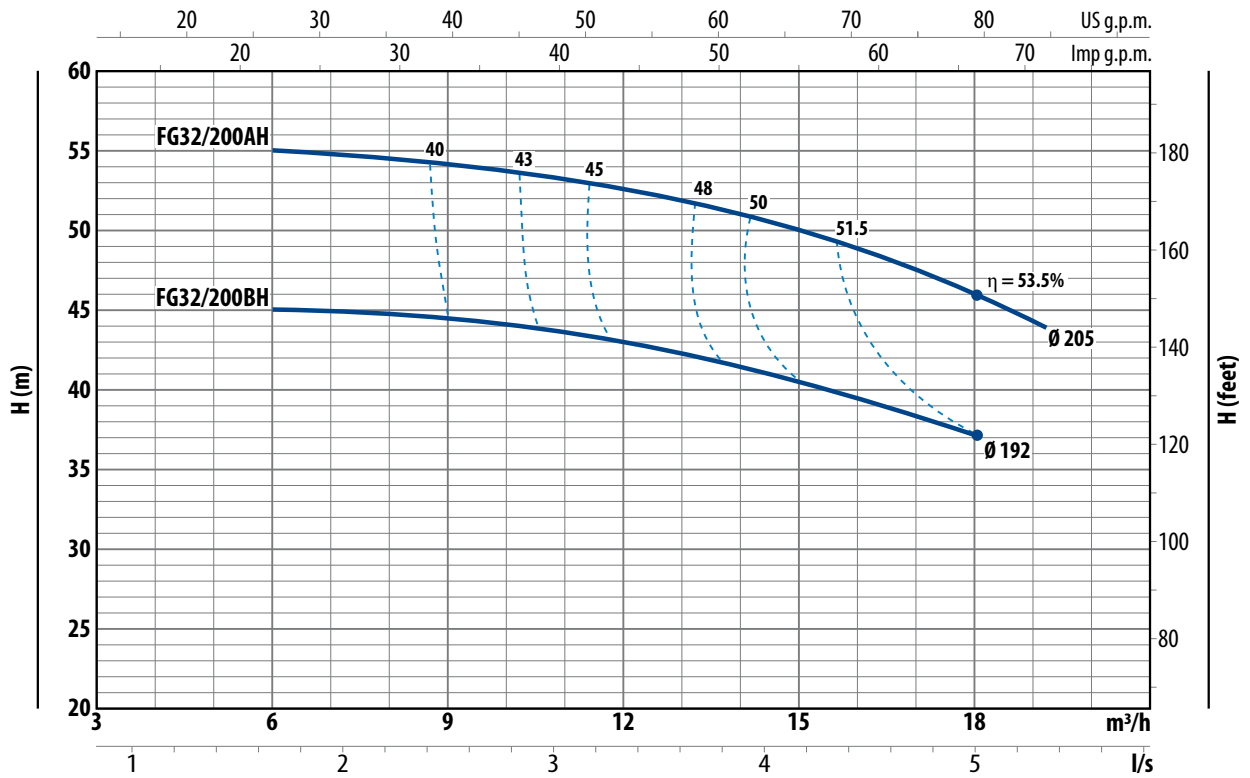

CHARACTERISTIC CURVES

n= 2900 1/min 2 Pole 50 Hz HS= 0 m

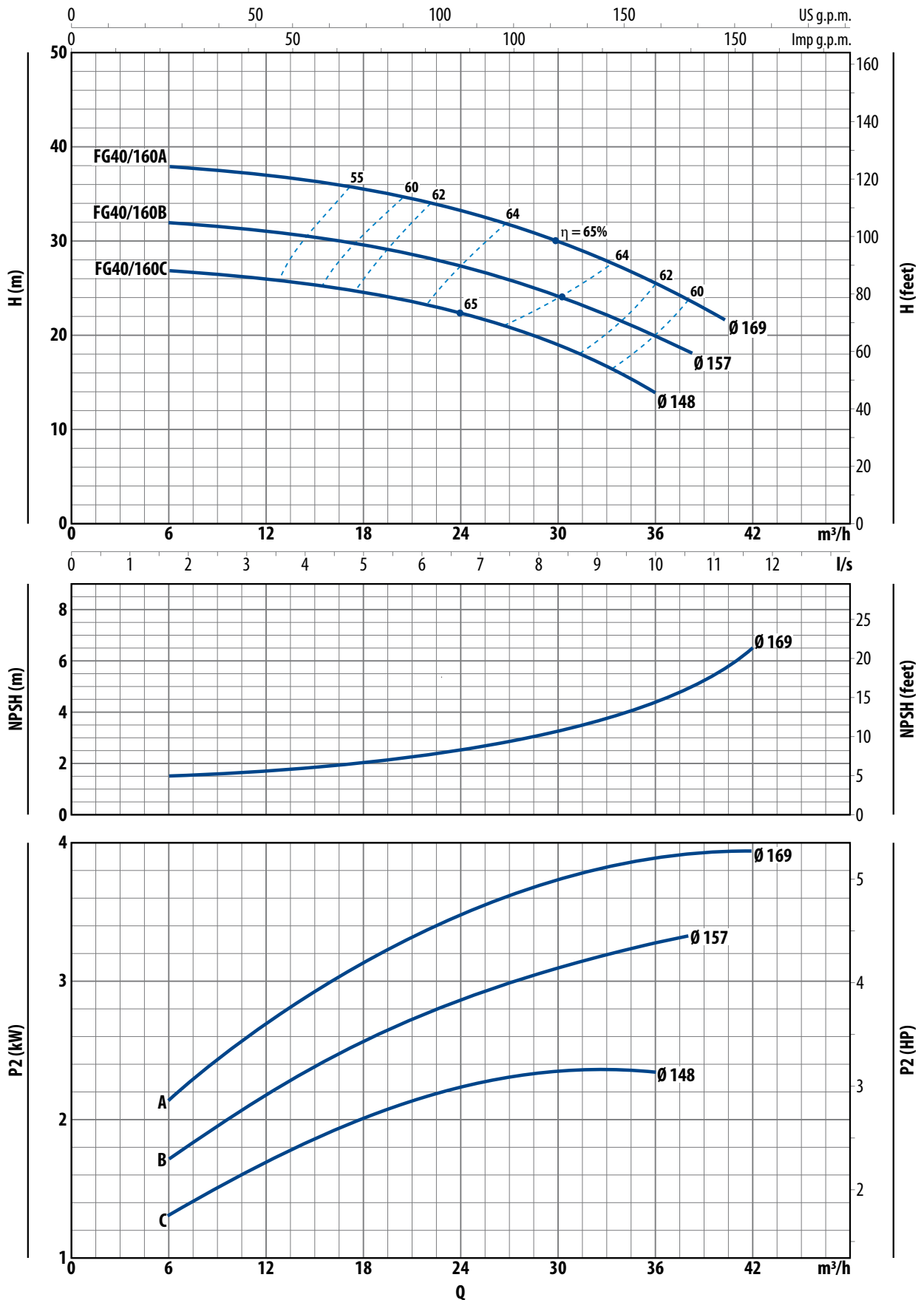

FG40/200

CHARACTERISTIC CURVES

n= 2900 1/min 2 Pole 50 Hz HS= 0 m

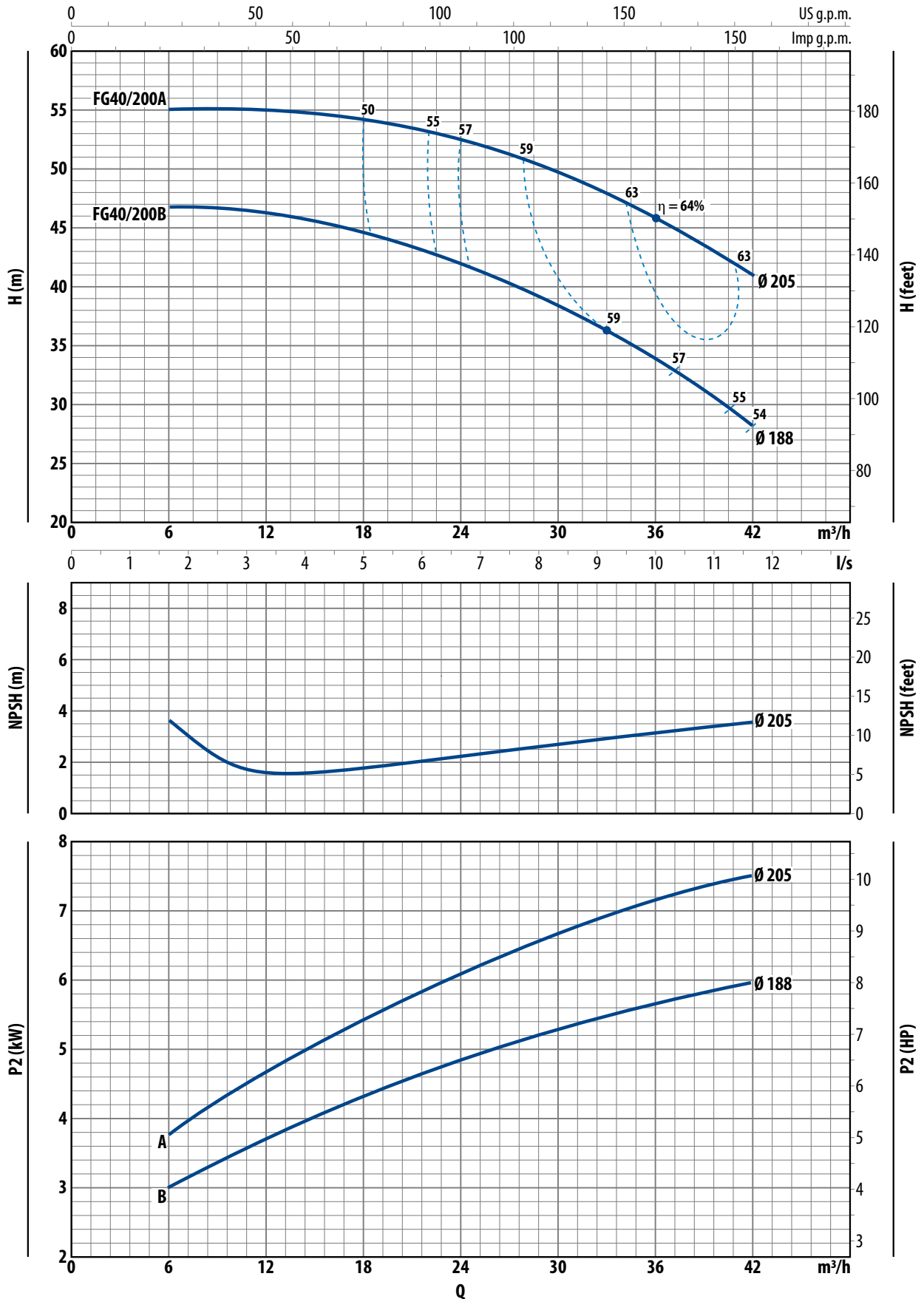

CHARACTERISTIC CURVES

n= 2900 1/min 2 Pole 50 Hz HS= 0 m

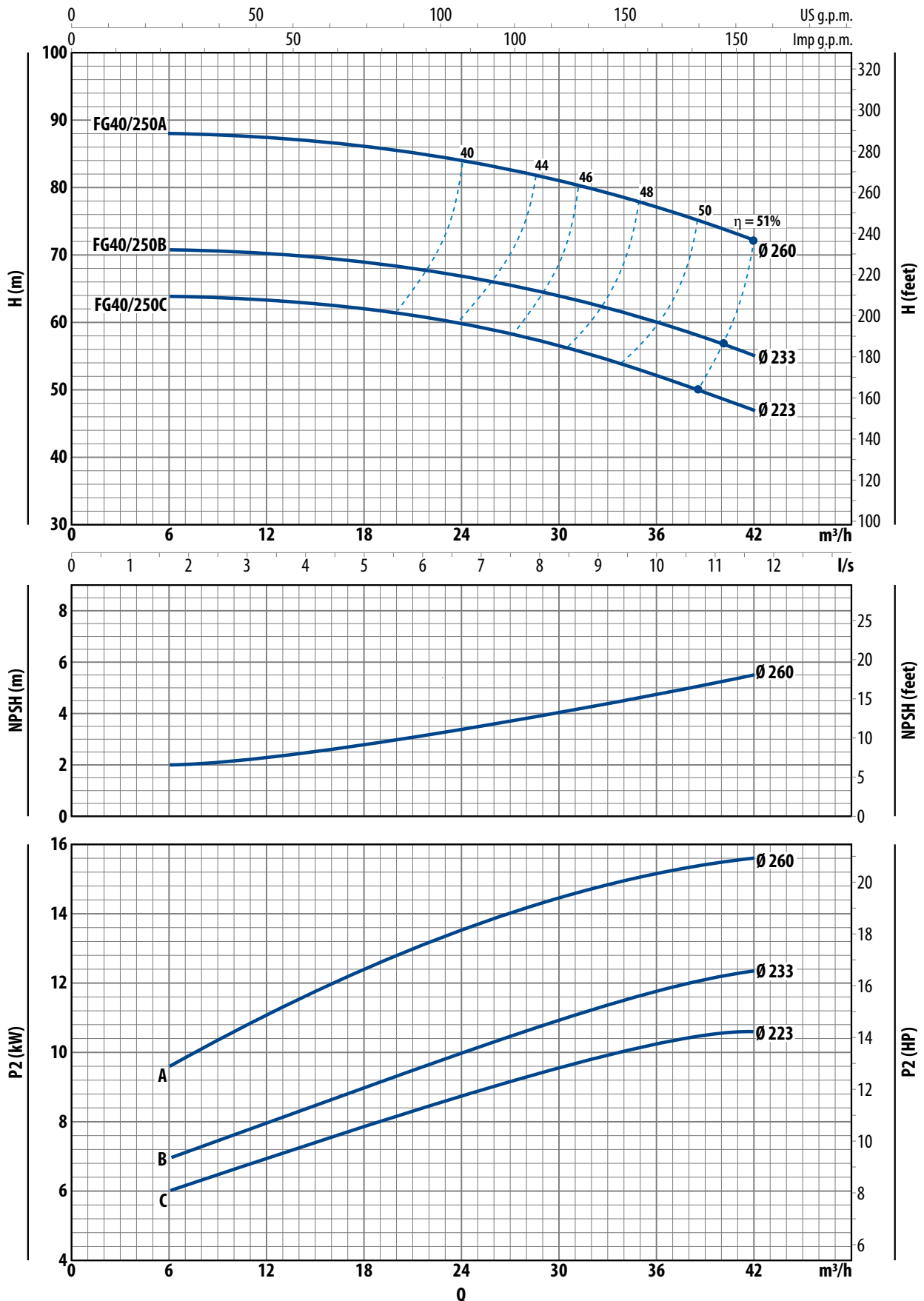

FG50/125

CHARACTERISTIC CURVES

n= 2900 1/min 2 Pole 50 Hz HS= 0 m

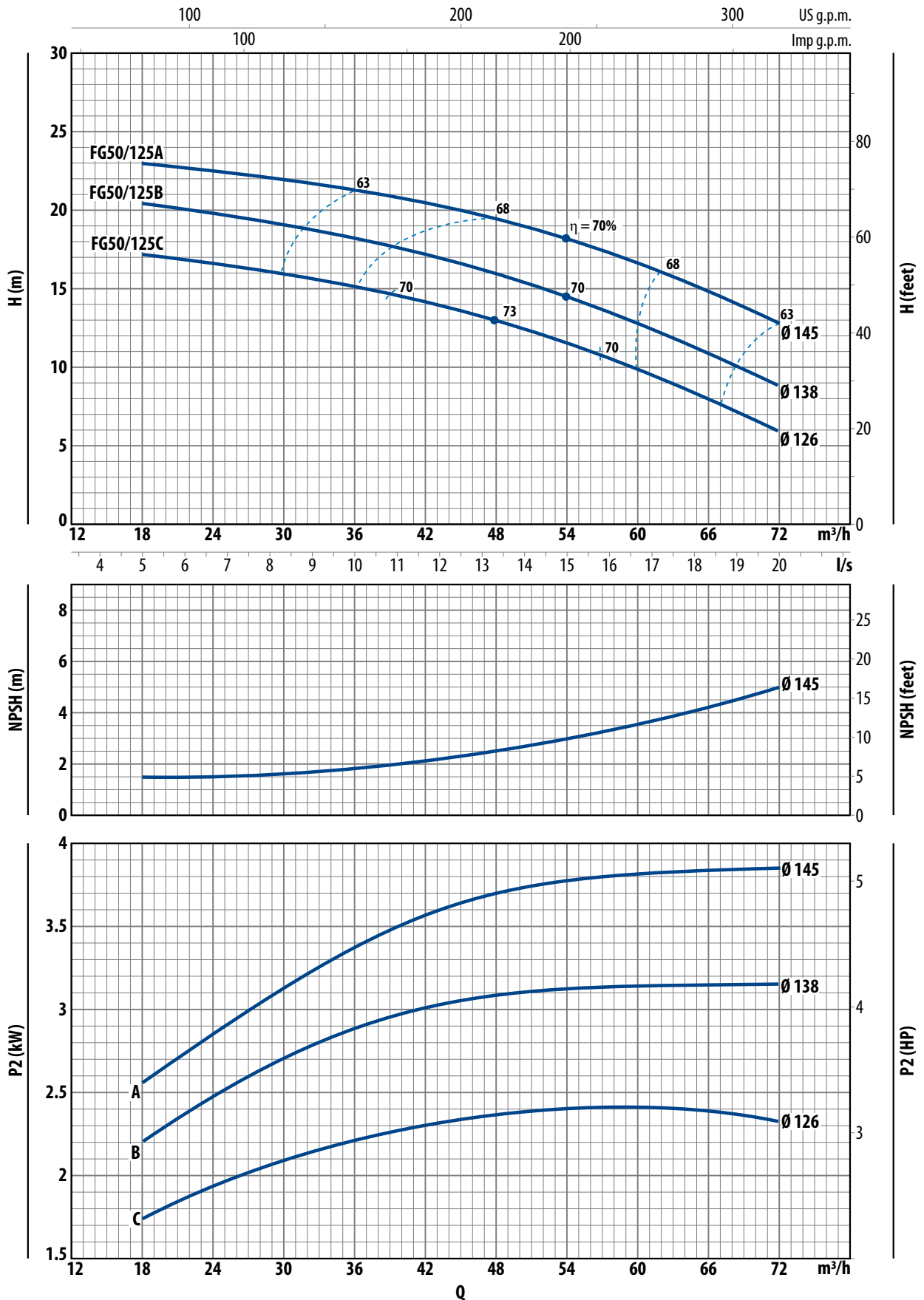

CHARACTERISTIC CURVES

n= 2900 1/min 2 Pole 50 Hz HS= 0 m

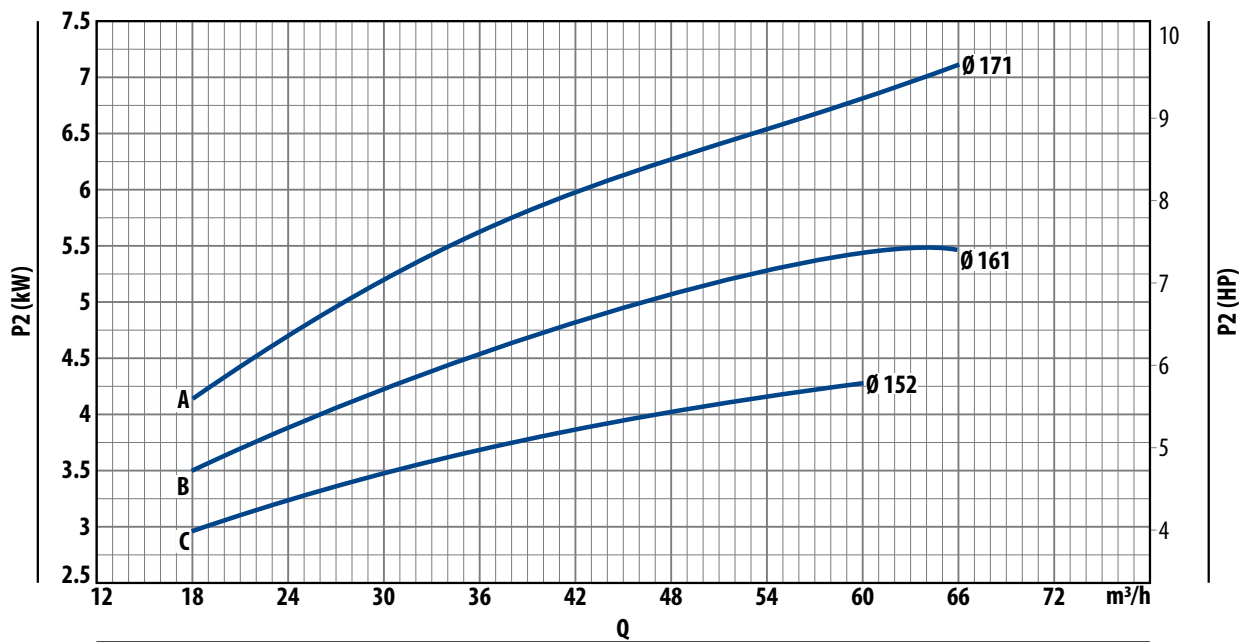
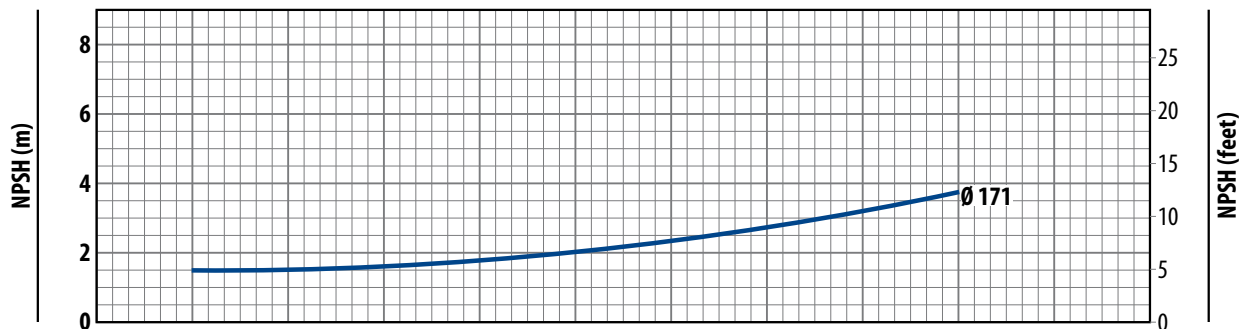
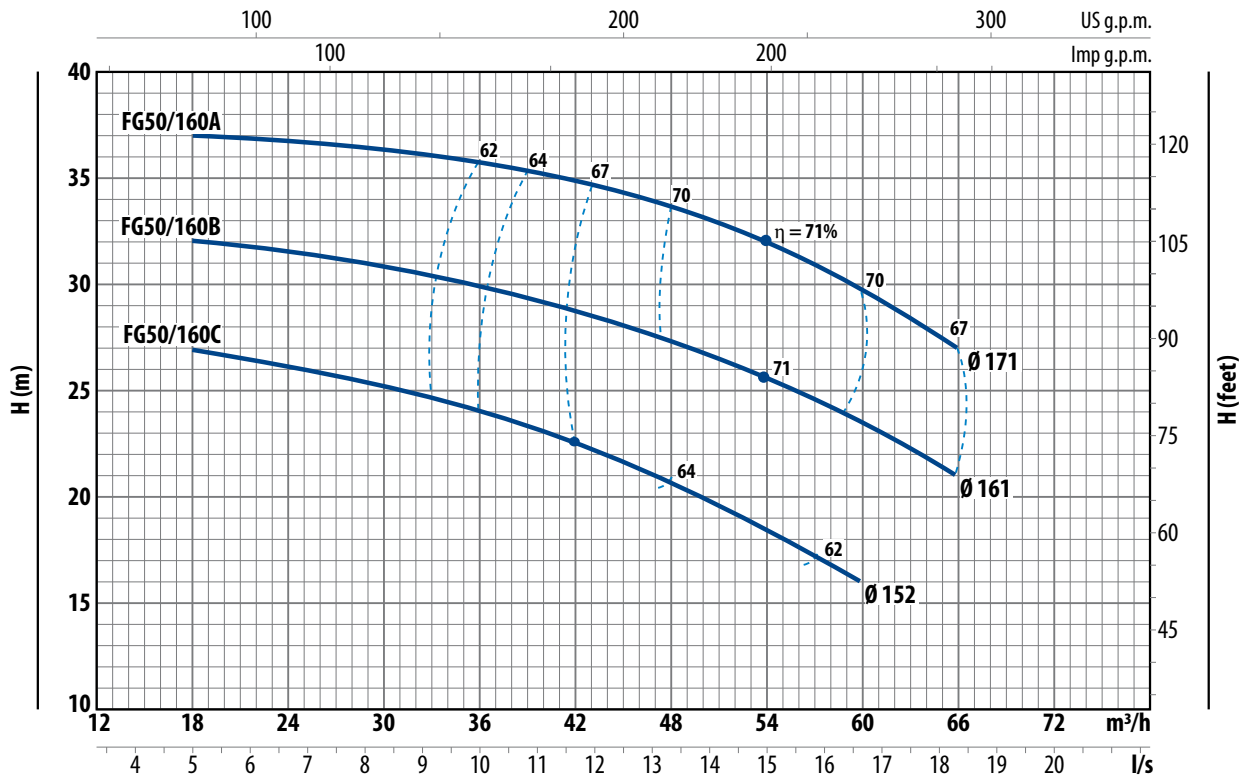

FG50/200

CHARACTERISTIC CURVES

n= 2900 1/min 2 Pole 50 Hz HS= 0 m

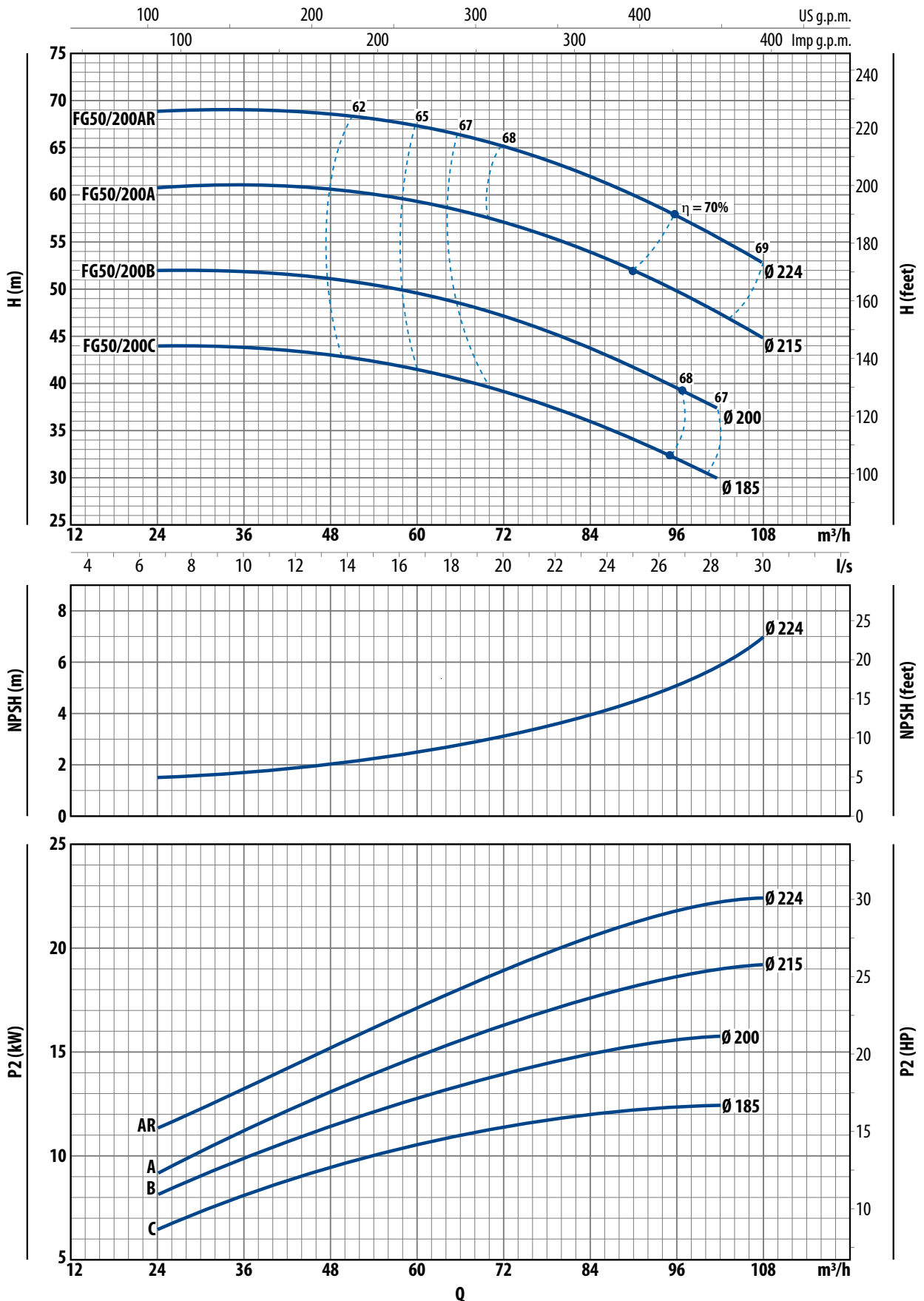

CHARACTERISTIC CURVES

n= 2900 1/min 2 Pole 50 Hz HS= 0 m

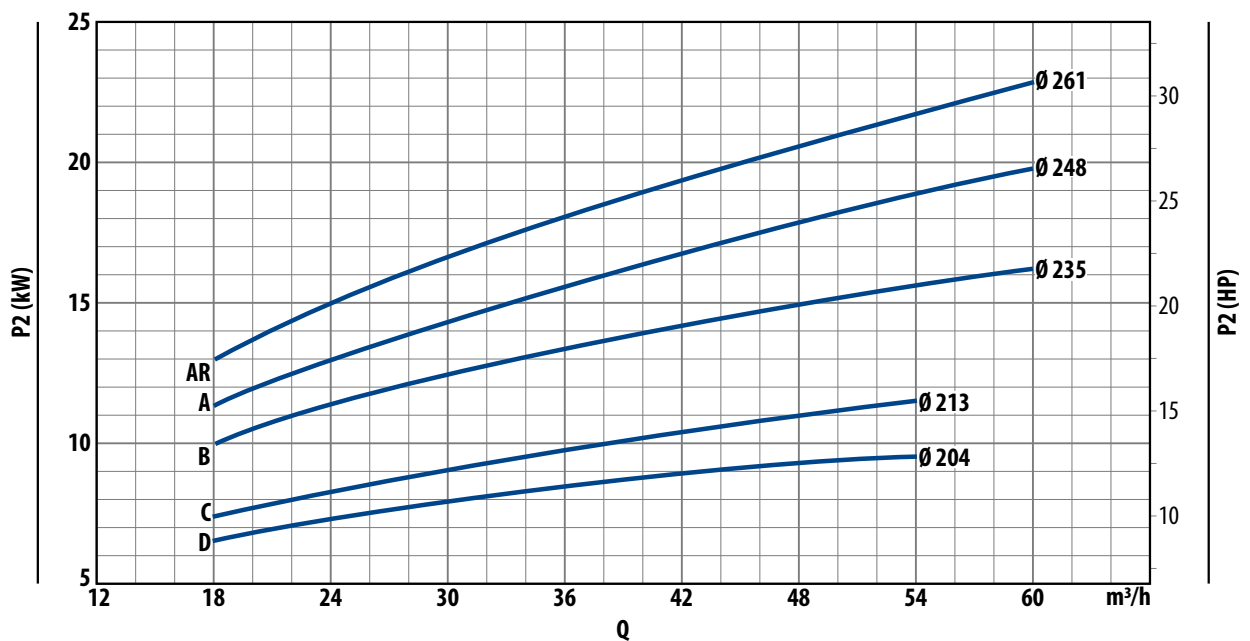
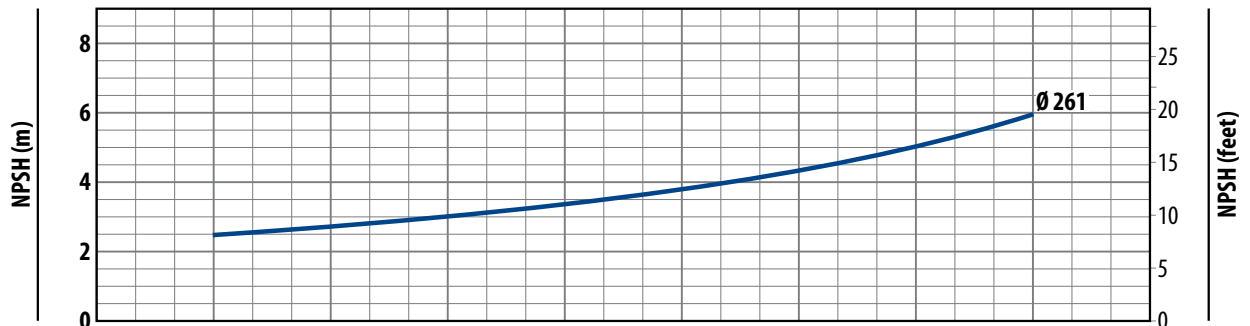
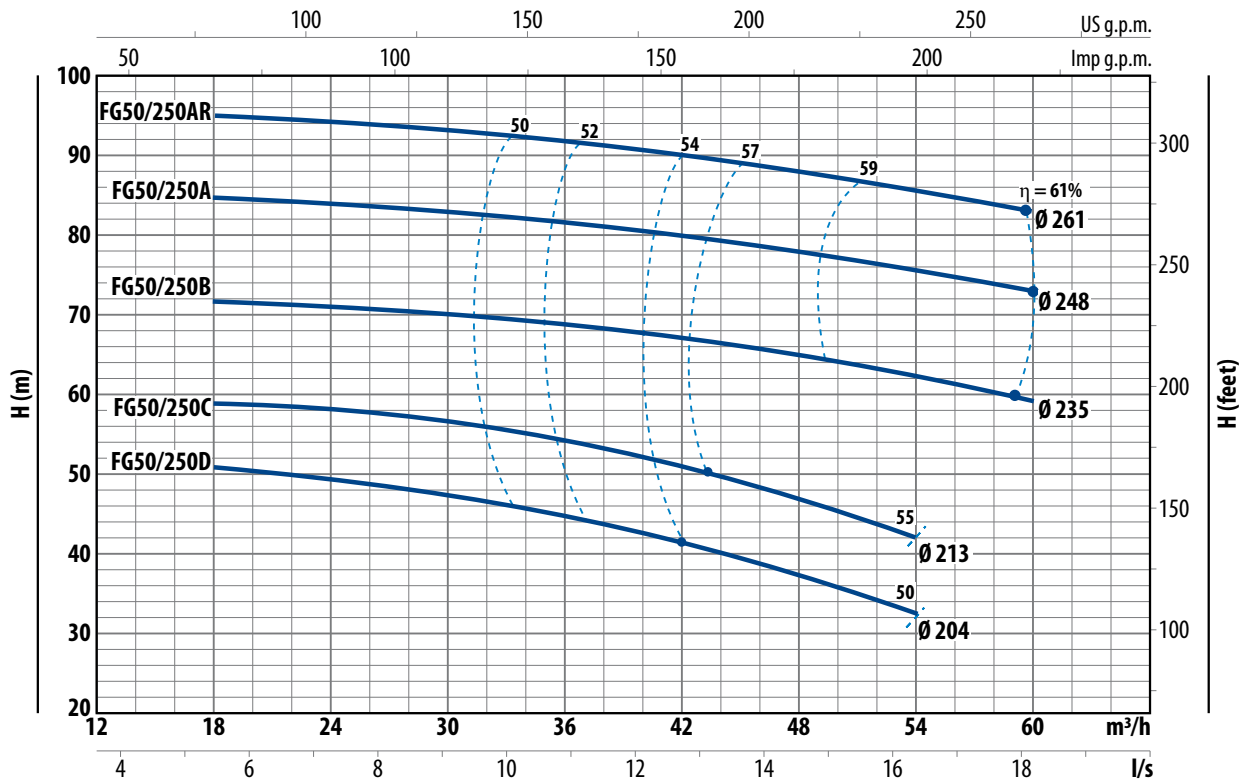

FG65/125

CHARACTERISTIC CURVES

n= 2900 1/min 2 Pole 50 Hz HS= 0 m

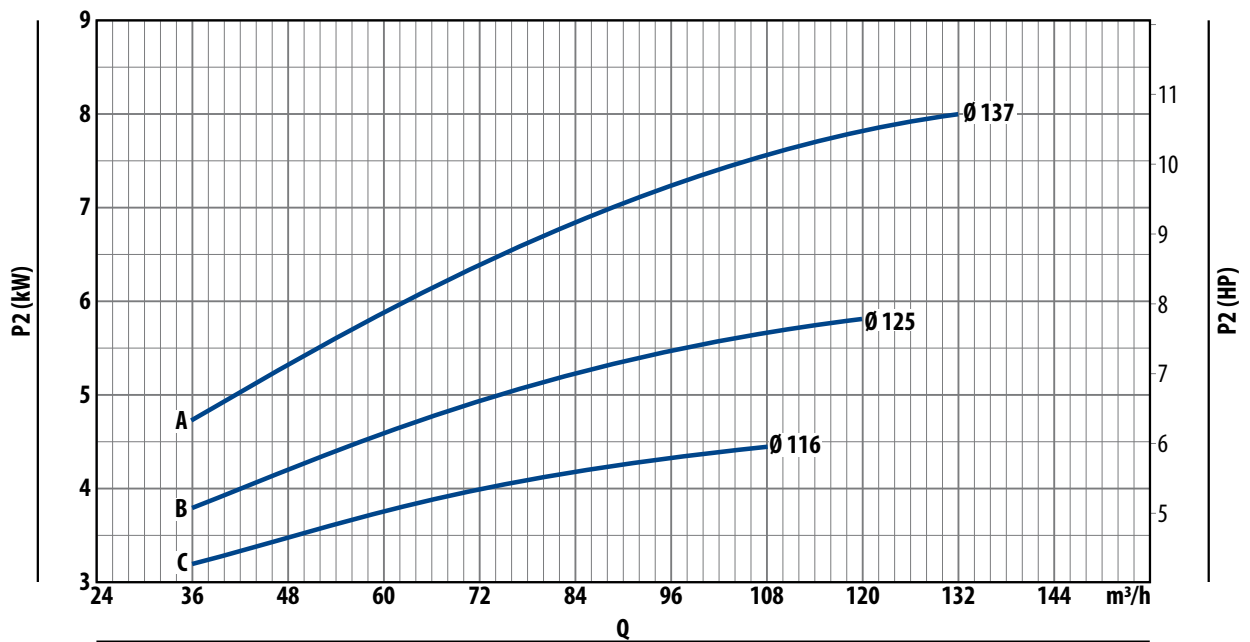
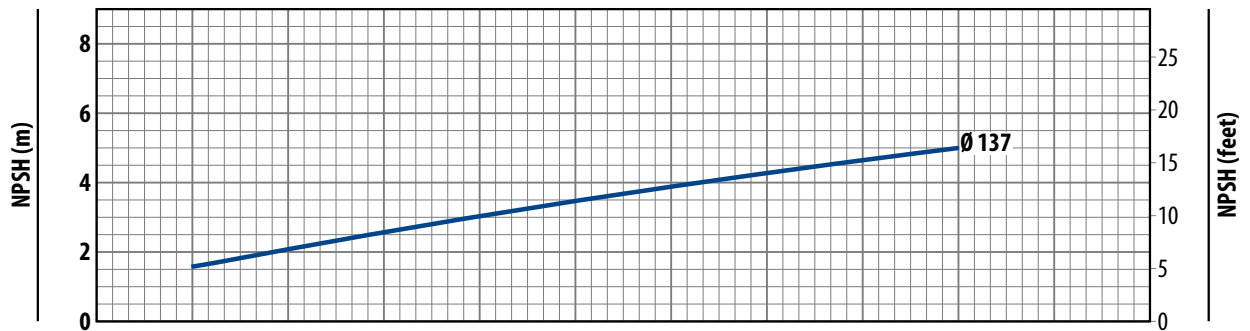
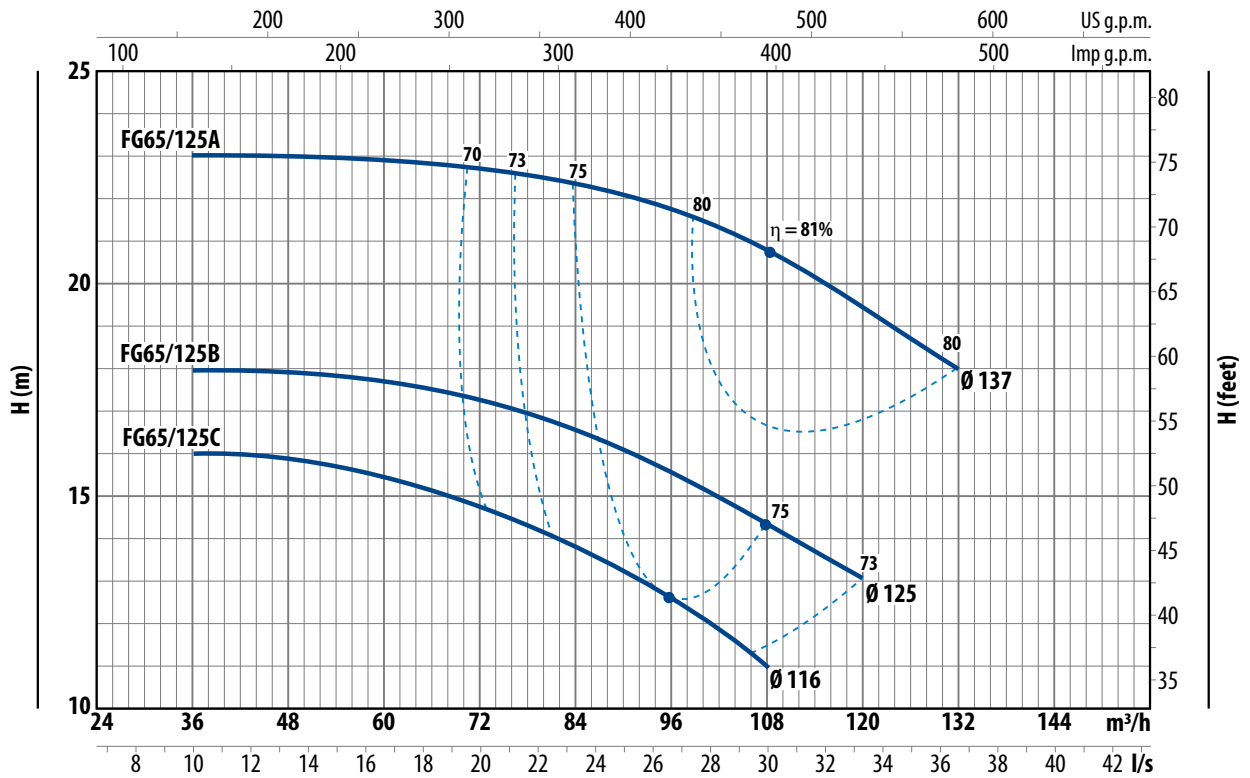

CHARACTERISTIC CURVES

n = 2900 1/min 2 Pole 50 Hz HS = 0 m

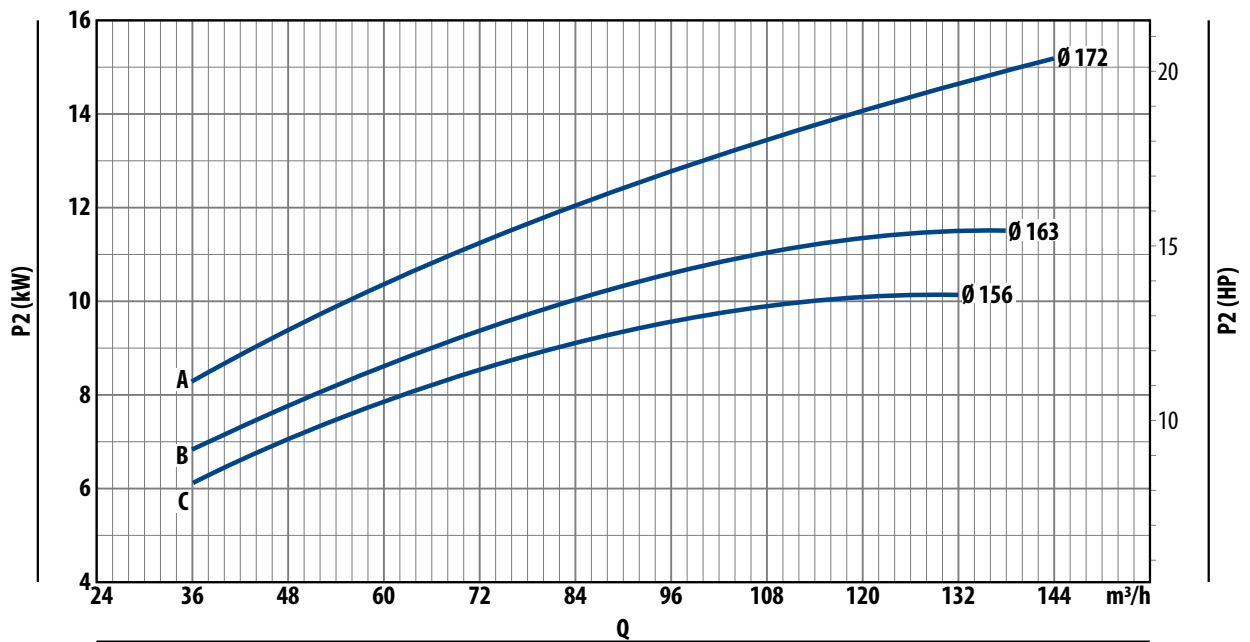
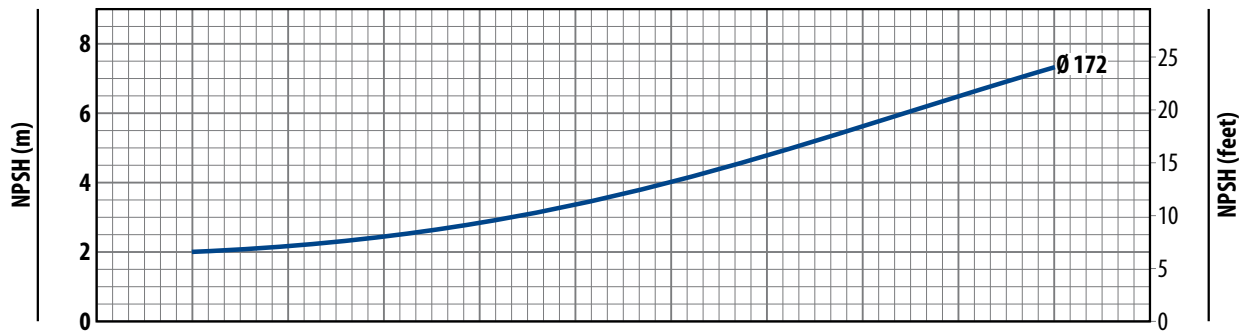
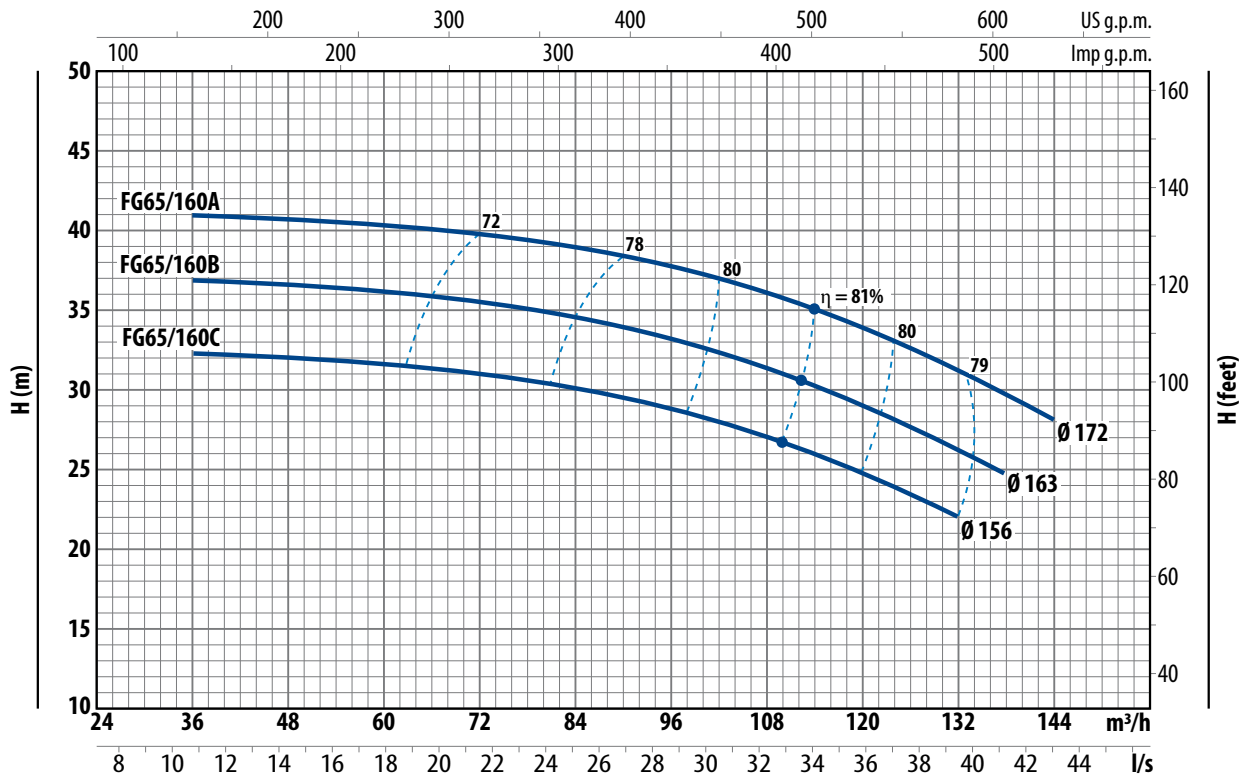

FG65/200

CHARACTERISTIC CURVES

n= 2900 1/min 2 Pole 50 Hz HS= 0 m

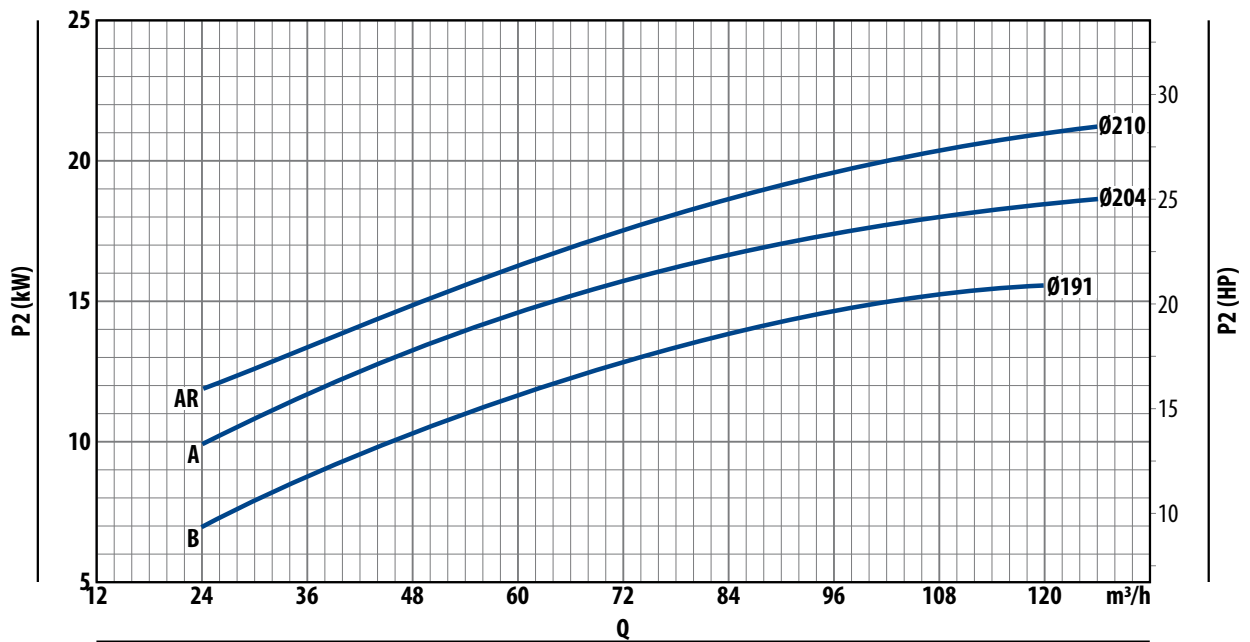
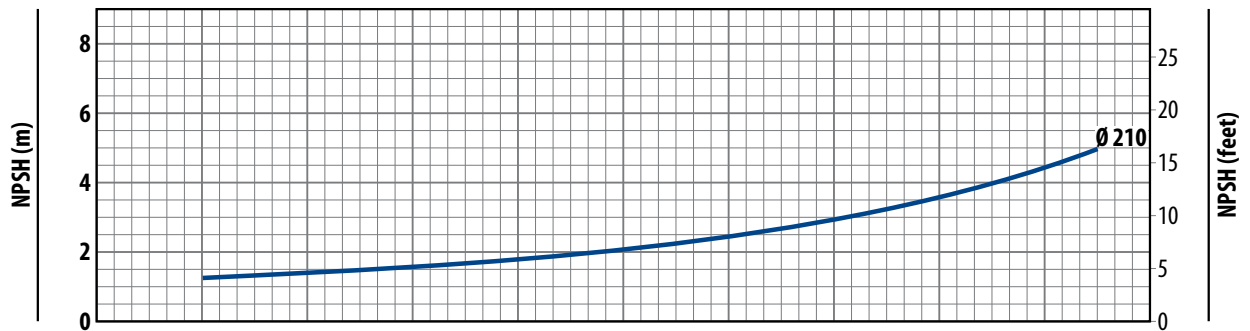
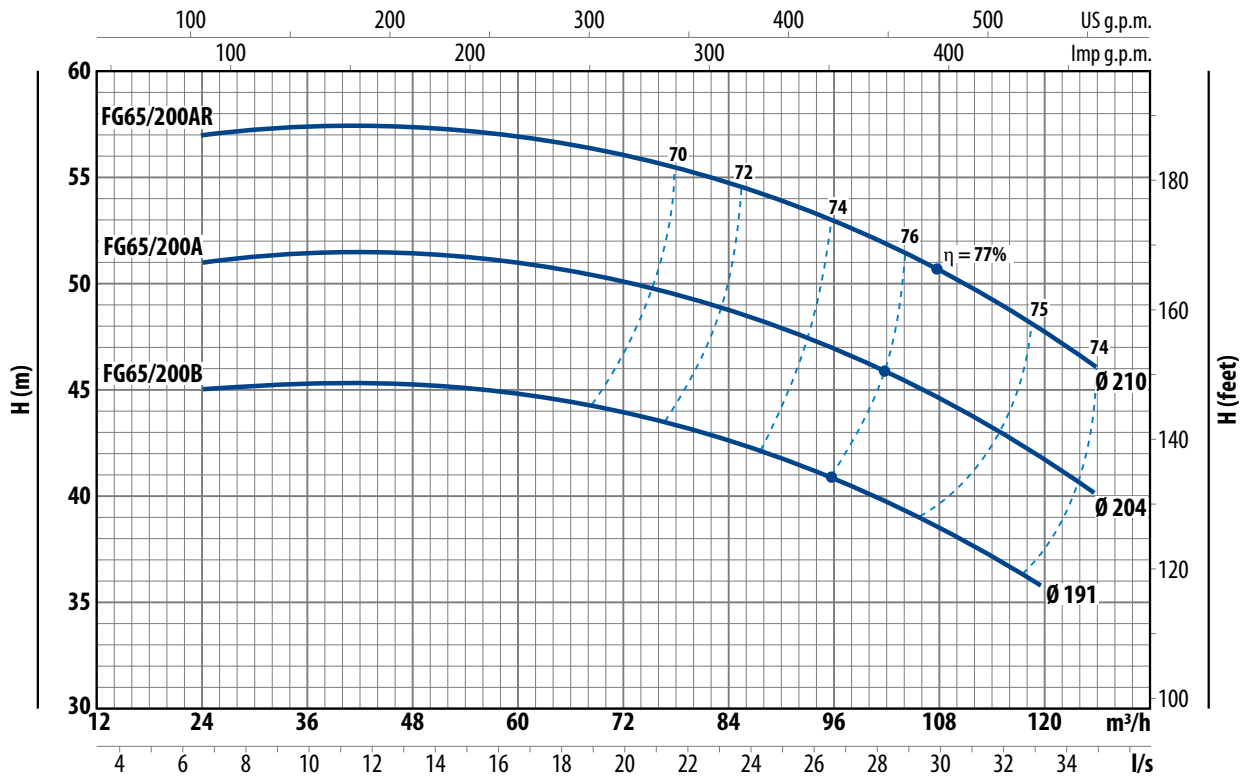

CHARACTERISTIC CURVES

n= 2900 1/min 2 Pole 50 Hz HS= 0 m

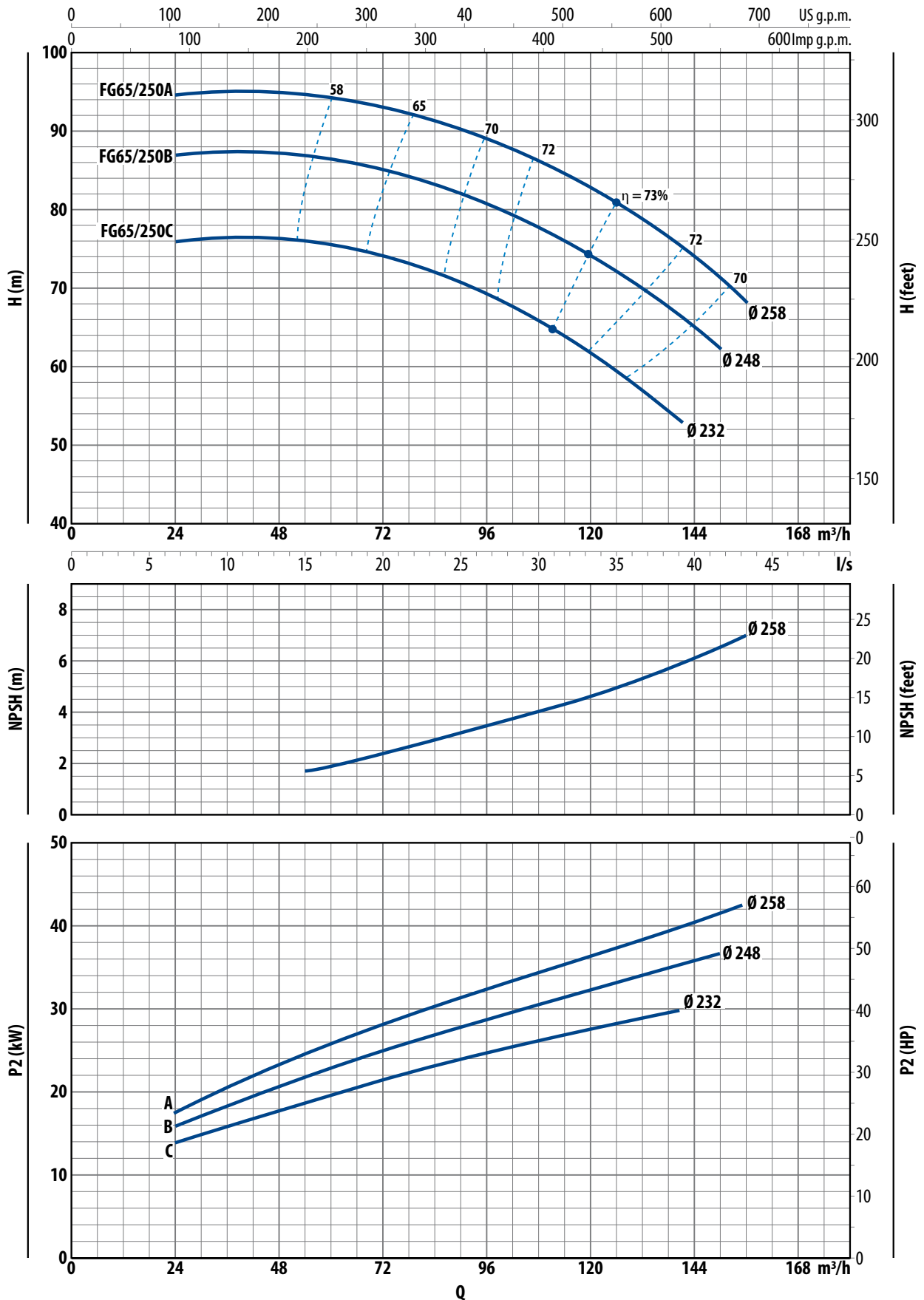

FG80/160

CHARACTERISTIC CURVES

n= 2900 1/min 2 Pole 50 Hz HS= 0 m

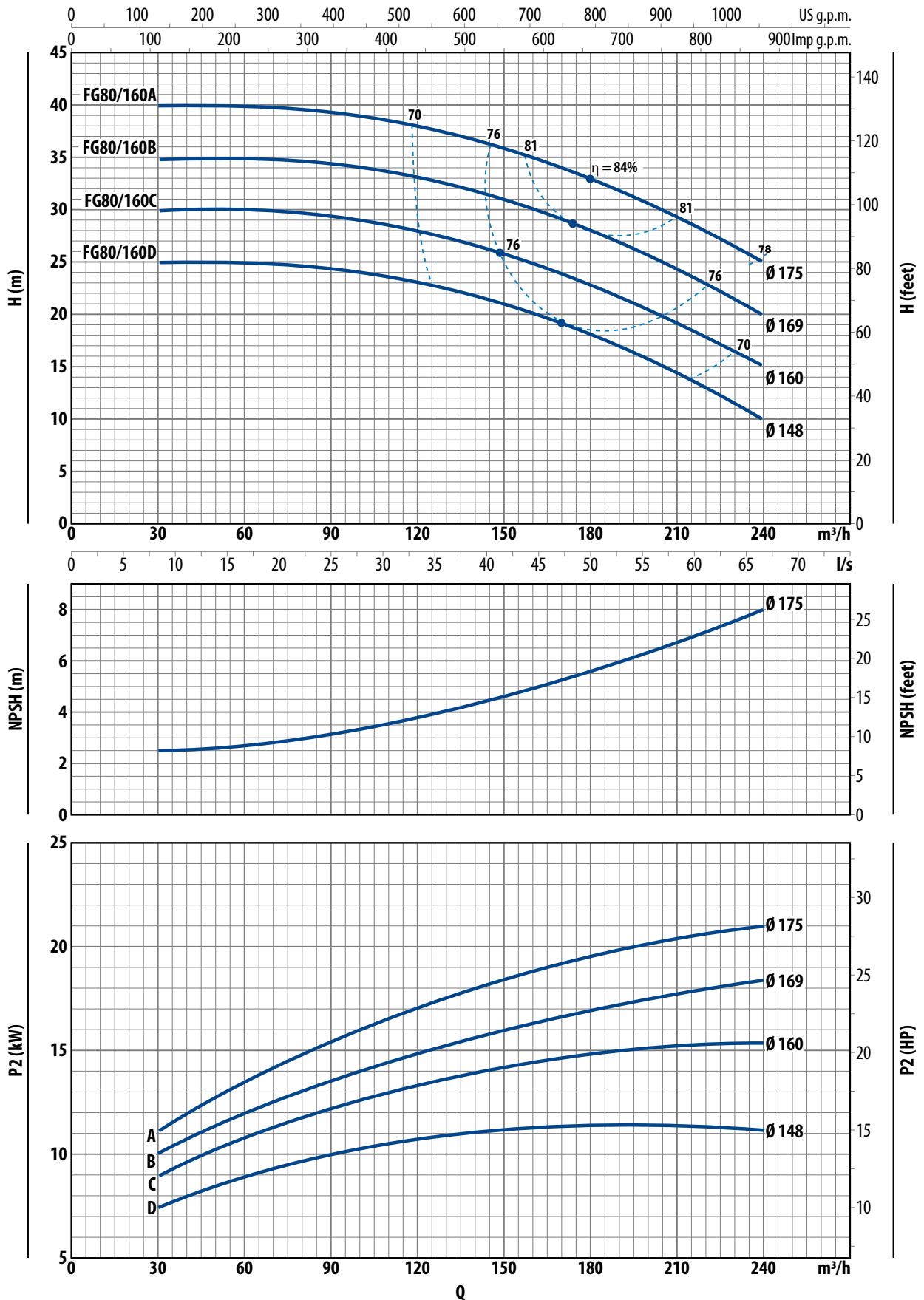

CHARACTERISTIC CURVES

n= 2900 1/min 2 Pole 50 Hz HS= 0 m

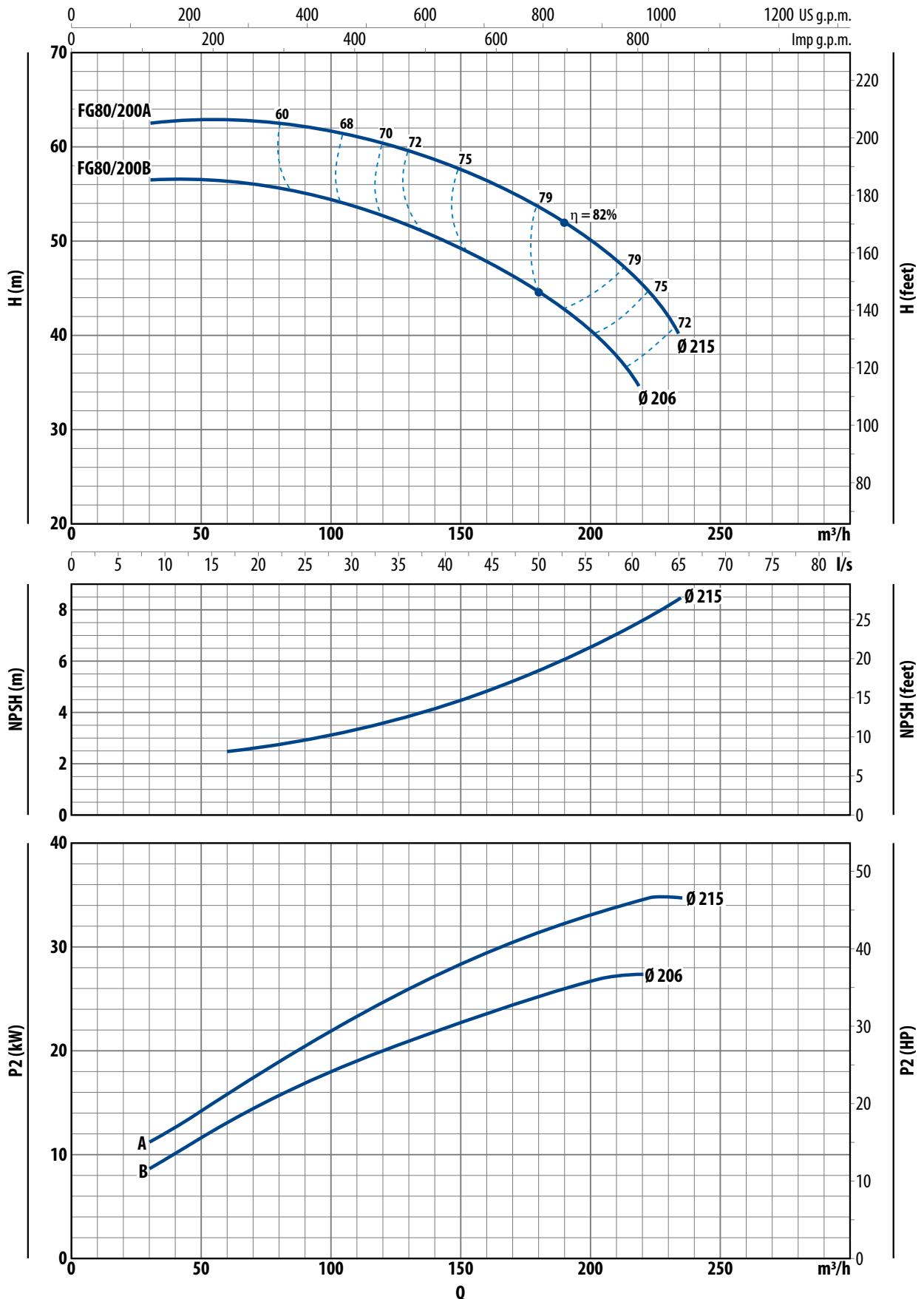

FG80/250

CHARACTERISTIC CURVES

n= 2900 1/min 2 Pole 50 Hz HS= 0 m

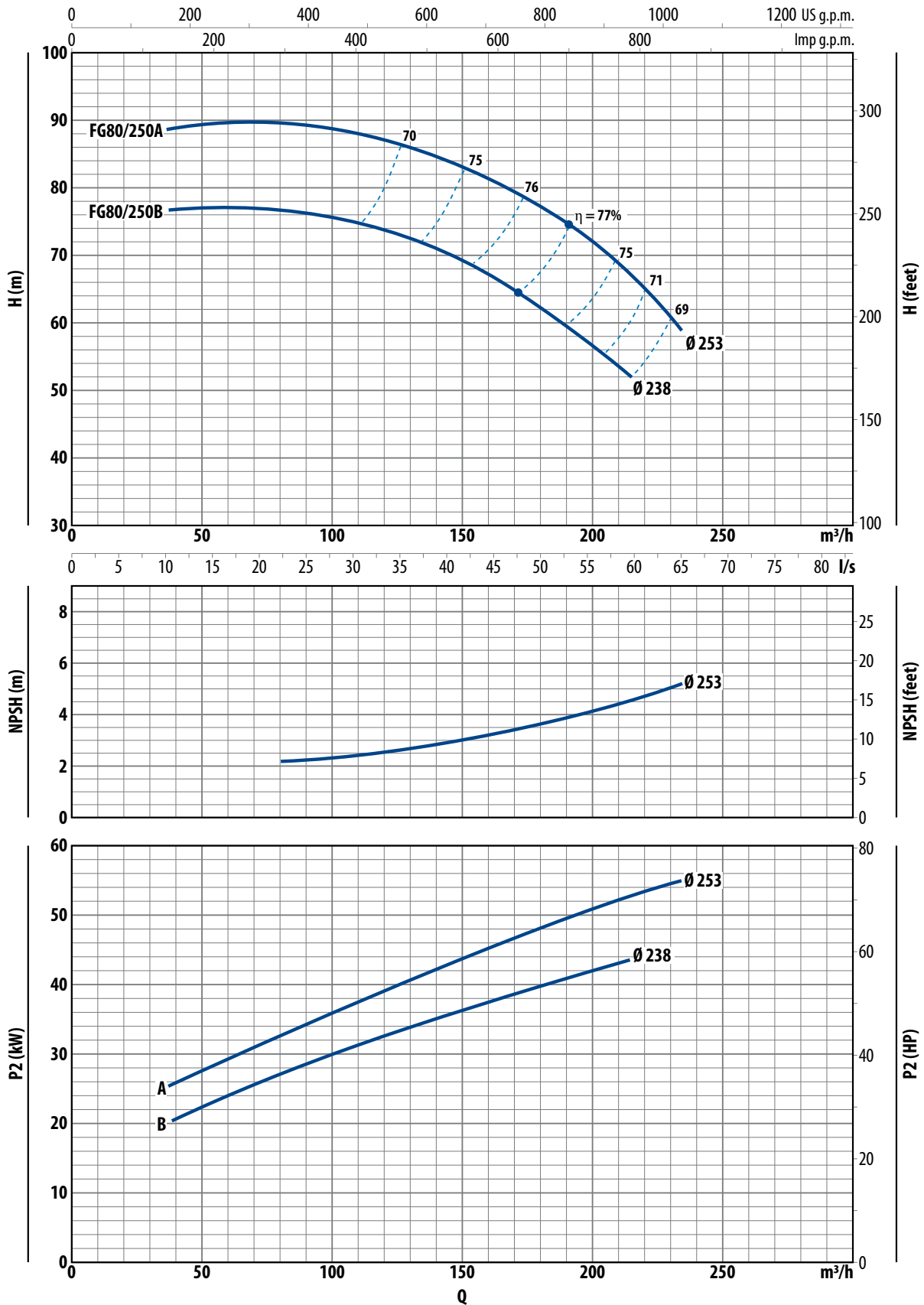

CHARACTERISTIC CURVES

n= 2900 1/min 2 Pole 50 Hz HS= 0 m

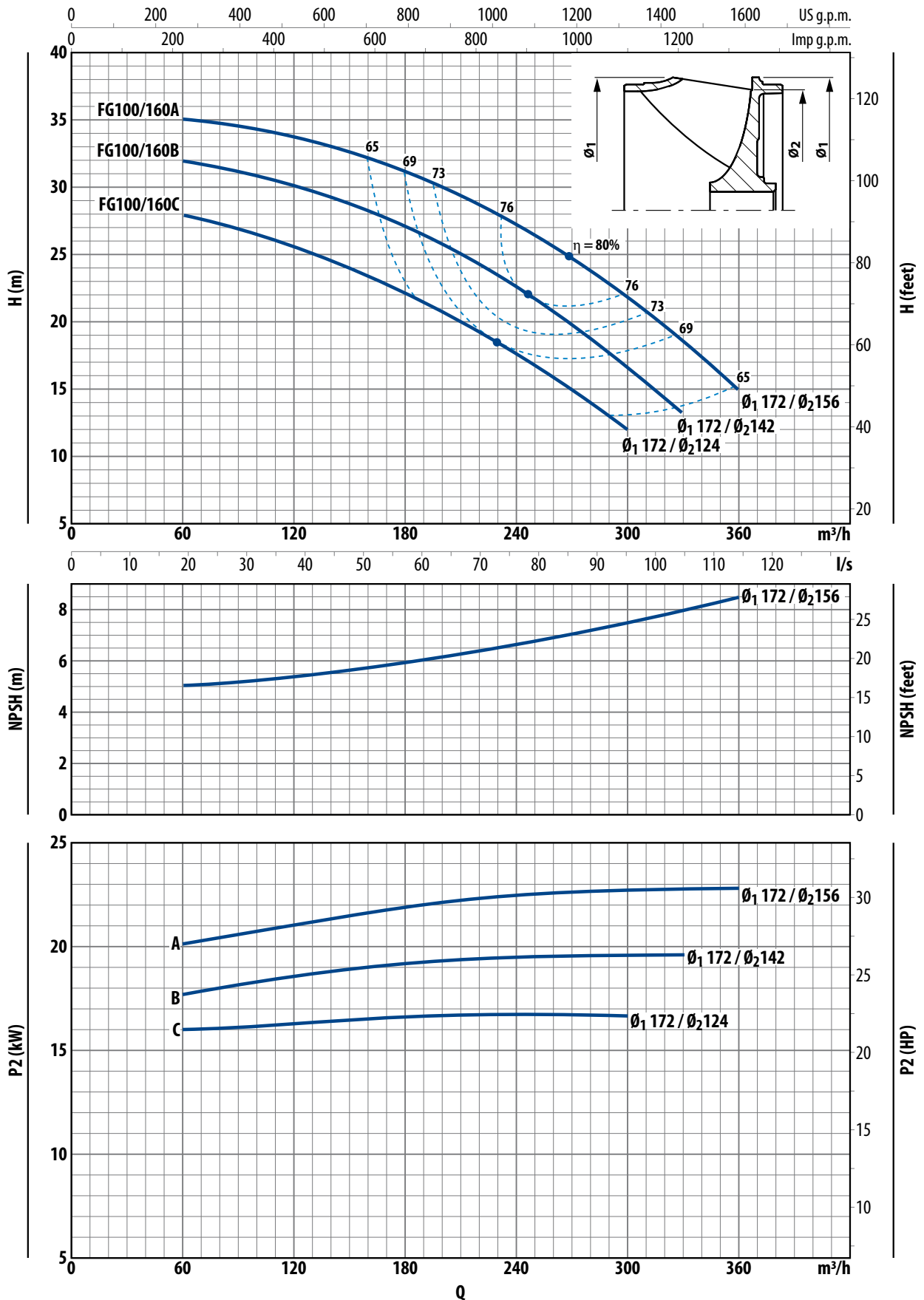

FG 100/200

CHARACTERISTIC CURVES

n= 2900 1/min 2 Pole 50 Hz HS= 0 m

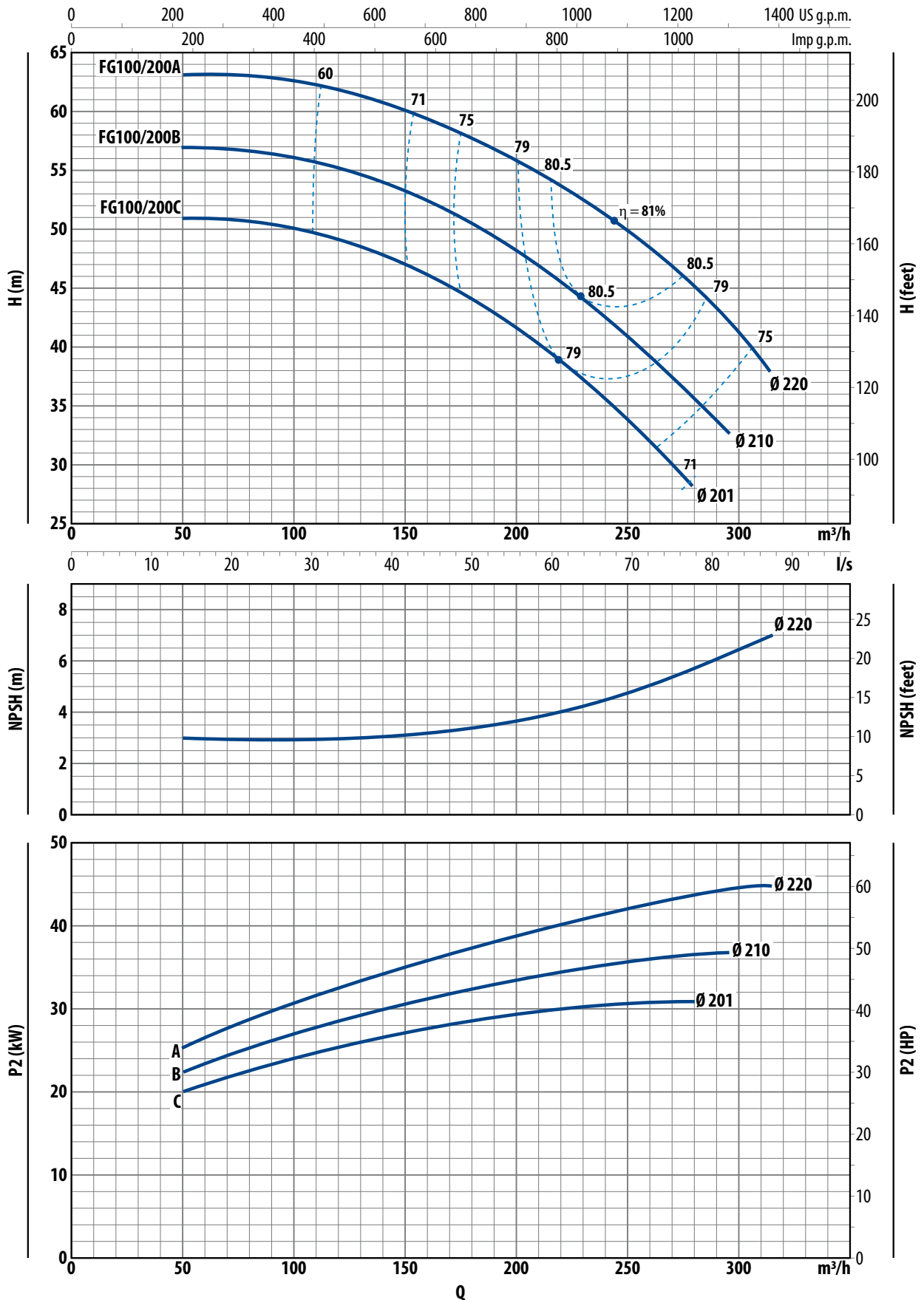

CHARACTERISTIC CURVES

n= 2900 1/min 2 Pole 50 Hz HS= 0 m

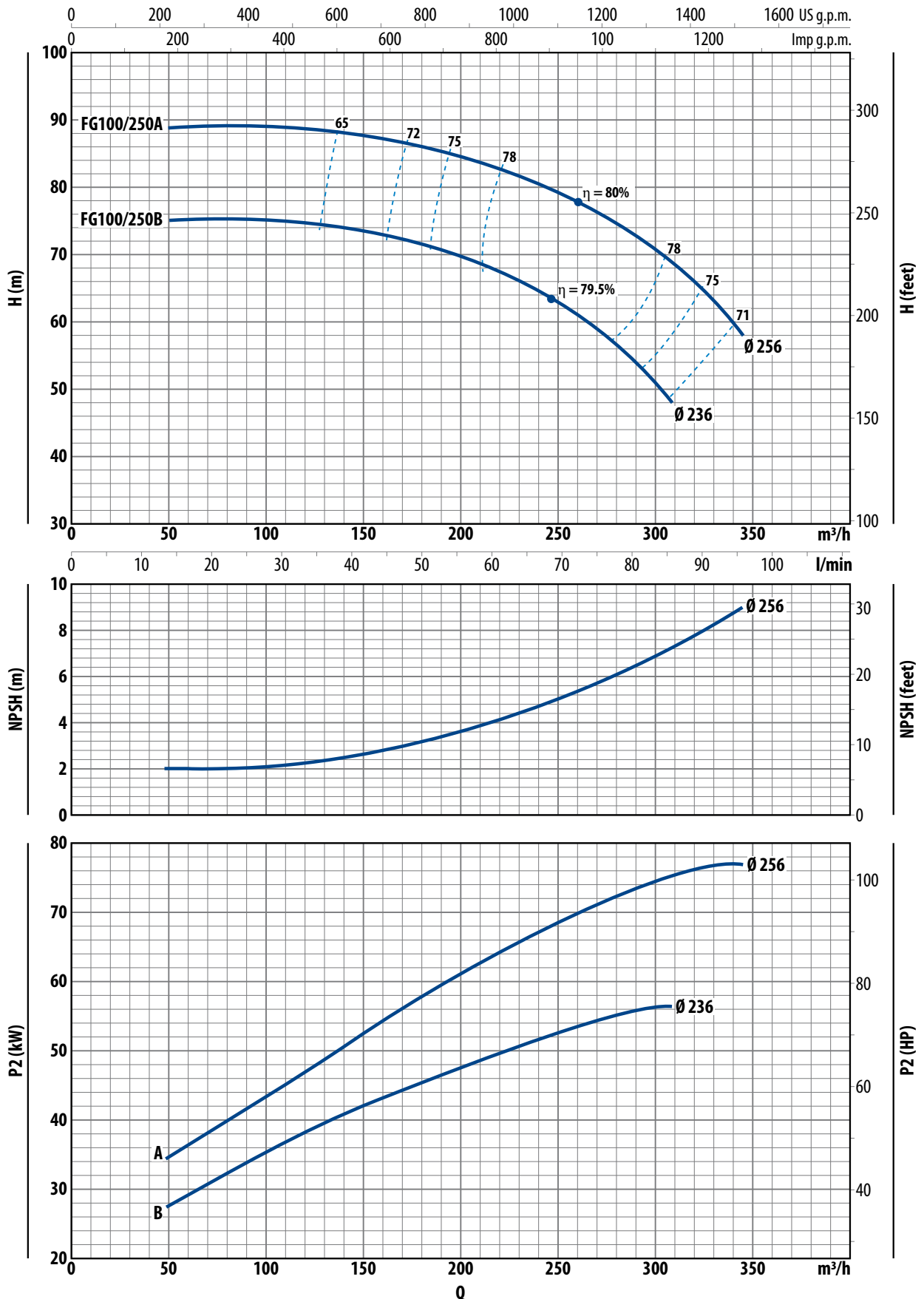

REGULATION (EU) N. 547/2012

- Minimum efficiency index $MEI \geq 0,10$ for water pumps according to the (EU) Regulation current from the 1th of January 2013.
- The benchmark for most efficient water pumps is $MEI \geq 0,70$.
- The efficiency of a pump with a trimmed impeller is usually lower than that of a pump with the full impeller diameter. The trimming of the impeller will adapt the pump to a fixed duty point, leading to reduced energy consumption. The minimum efficiency index (MEI) is based on the full impeller diameter.
- The operation of this water pump with variable duty points may be more efficient and economic when controlled, for example, by the use of a variable speed drive that matches the pump duty to the system.
- Information on benchmark efficiency is available www.europump.org/efficiencycharts.

Notes

A series of 23 horizontal dotted lines providing a template for handwritten notes.



PEDROLLO SpA

Via Enrico Fermi 7 - 37047 San Bonifacio (VR) ITALY
tel. +39 045 6136311 - fax +39 045 7614663
sales@pedrollo.com - **www.pedrollo.com**

FG

Standardised "EN 733" centrifugal pumps



CHARACTERISTIC CURVES

n = 1450 1/min 4 Pole 50 Hz

 **PEDROLLO**[®]
... the spring of life

PERFORMANCE RANGE

n= 1450 1/min 4 Pole 50 Hz HS= 0 m

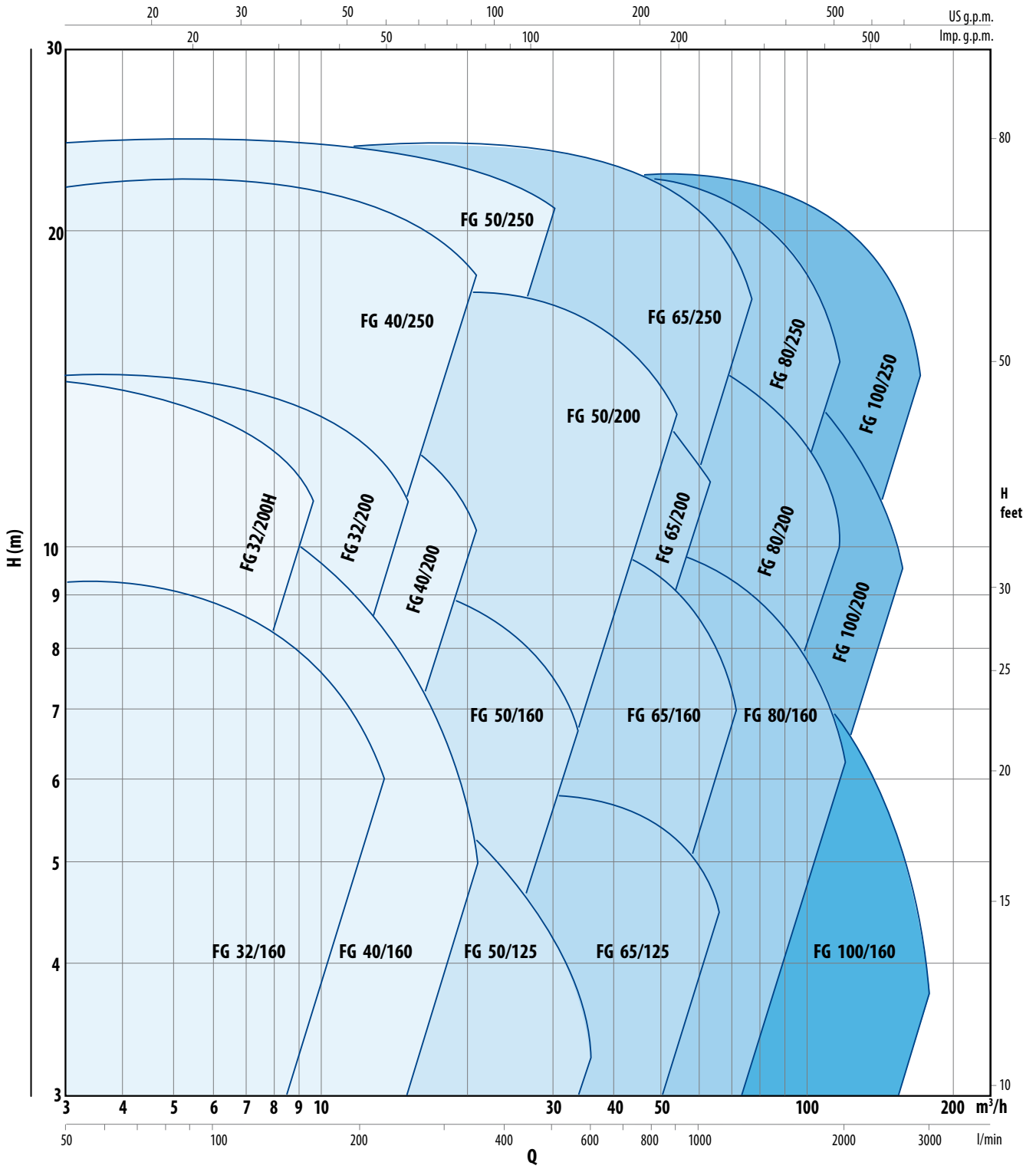

- Hydraulic performance and connection dimensions compliant with standard EN 733.
- The declared performances are valid for liquids with density 1000 kg/m³, kinematic viscosity 1 mm²/s and water temperature 15 °C.
- Tolerance of characteristic curves in compliance with EN ISO 9906 Grado 3.

PERFORMANCE DATA
n= 1450 1/min 4 Pole 50 Hz HS= 0 m

MODEL pump	MOTOR PAIRING		PERFORMANCE	
	kW	HP	Q m ³ /h	H metres
FG 32/160C	0.25	0.33	3 ÷ 10.5	6 ÷ 3.5
FG 32/160B	0.37	0.5	3 ÷ 12	7.5 ÷ 4
FG 32/160A	0.37	0.5	3 ÷ 13.5	9 ÷ 6
FG 32/200C	0.55	0.75	3 ÷ 13.5	11 ÷ 8
FG 32/200B	0.75	1	3 ÷ 15	12.5 ÷ 9
FG 32/200A	1.1	1.5	3 ÷ 15	14 ÷ 11
FG 32/200BH	0.55	0.75	3 ÷ 9	11 ÷ 9
FG 32/200AH	0.55	0.75	3 ÷ 9.6	13.5 ÷ 11
FG 40/160C	0.37	0.5	3 ÷ 18	6.5 ÷ 3.5
FG 40/160B	0.37	0.5	3 ÷ 18	8 ÷ 5
FG 40/160A	0.55	0.75	3 ÷ 21	9.5 ÷ 5
FG 40/200B	0.75	1	3 ÷ 21	11.5 ÷ 7
FG 40/200A	1.1	1.5	3 ÷ 21	13.5 ÷ 10
FG 40/250C	1.1	1.5	3 ÷ 21	16 ÷ 11.5
FG 40/250B	1.5	2	3 ÷ 21	17.5 ÷ 13.5
FG 40/250A	2.2	3	3 ÷ 21	22 ÷ 18
FG 50/125C	0.37	0.5	9 ÷ 36	4 ÷ 1.5
FG 50/125B	0.55	0.75	9 ÷ 36	5 ÷ 2
FG 50/125A	0.55	0.75	9 ÷ 36	6 ÷ 3
FG 50/160C	0.55	0.75	9 ÷ 30	7 ÷ 4
FG 50/160B	0.75	1	9 ÷ 33	8 ÷ 5
FG 50/160A	1.1	1.5	9 ÷ 33	9 ÷ 7
FG 50/200C	1.5	2	12 ÷ 51	11 ÷ 7.5
FG 50/200B	2.2	3	12 ÷ 51	13 ÷ 9.5
FG 50/200A	2.2	3	12 ÷ 54	15 ÷ 11
FG 50/200AR	3	4	12 ÷ 54	17 ÷ 13
FG 50/250D	1.1	1.5	9 ÷ 27	12.5 ÷ 8
FG 50/250C	1.5	2	9 ÷ 27	14.5 ÷ 10.5
FG 50/250B	2.2	3	9 ÷ 30	18 ÷ 14.5
FG 50/250A	2.2	3	9 ÷ 30	21 ÷ 18
FG 50/250AR	3	4	9 ÷ 30	24 ÷ 21
FG 65/125C	0.55	0.75	18 ÷ 54	4 ÷ 2.5
FG 65/125B	0.75	1	18 ÷ 60	4.5 ÷ 3
FG 65/125A	1.1	1.5	18 ÷ 66	5.5 ÷ 4.5
FG 65/160C	1.1	1.5	18 ÷ 66	8 ÷ 5.5
FG 65/160B	1.5	2	18 ÷ 72	9 ÷ 5.5
FG 65/160A	2.2	3	18 ÷ 72	10 ÷ 7
FG 65/200B	2.2	3	12 ÷ 60	11 ÷ 9
FG 65/200A	2.2	3	12 ÷ 63	12.5 ÷ 10
FG 65/200AR	3	4	12 ÷ 63	14.3 ÷ 11.5
FG 65/250C	3	4	12 ÷ 70.5	19 ÷ 13
FG 65/250B	4	5.5	12 ÷ 75	21.5 ÷ 15.5
FG 65/250A	5.5	7.5	12 ÷ 78	23.5 ÷ 17

MODEL pump	MOTOR PAIRING		PERFORMANCE	
	kW	HP	Q m ³ /h	H metres
FG 80/160D	1.5	2	15 ÷ 120	6 ÷ 2.5
FG 80/160C	2.2	3	15 ÷ 120	7.5 ÷ 3.5
FG 80/160B	2.2	3	15 ÷ 120	8.5 ÷ 5
FG 80/160A	3	4	15 ÷ 120	10 ÷ 6
FG 80/200B	4	5.5	15 ÷ 109.5	14 ÷ 8.5
FG 80/200A	5.5	7.5	15 ÷ 117	15.5 ÷ 10
FG 80/250B	5.5	7.5	18 ÷ 108	19 ÷ 13.5
FG 80/250A	7.5	10	18 ÷ 117	22 ÷ 15
FG 100/160C	2.2	3	30 ÷ 150	7 ÷ 3
FG 100/160B	3	4	30 ÷ 165	8 ÷ 3
FG 100/160A	3	4	30 ÷ 180	8.5 ÷ 3.5
FG 100/200C	4	5.5	24 ÷ 139.5	12.5 ÷ 7
FG 100/200B	5.5	7.5	24 ÷ 147	14 ÷ 8
FG 100/200A	5.5	7.5	24 ÷ 157.5	15.5 ÷ 9.5
FG 100/250B	7.5	10	24 ÷ 154.5	18.5 ÷ 12
FG 100/250A	9.2	12.5	24 ÷ 172.5	22 ÷ 14.5

DIMENSIONS AND WEIGHT

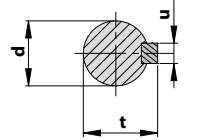
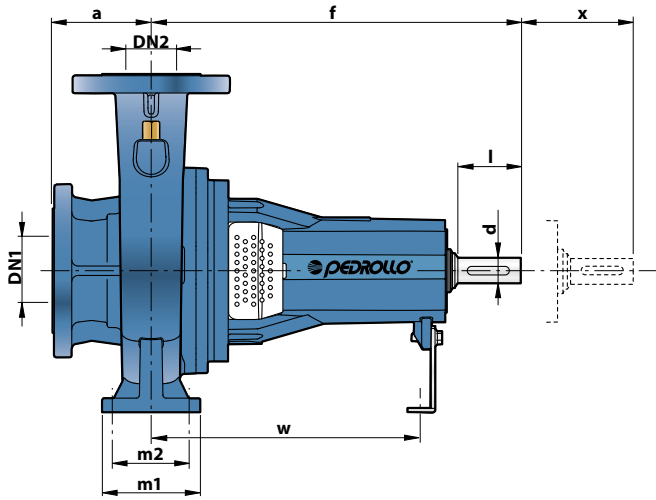

SHAFT DIMENSIONS		
mm		
d	u	t
24 k6	8	27
32 k6	10	35

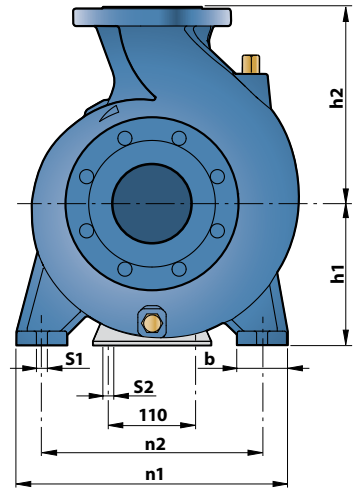

DN FLANGES	D mm	K mm	HOLES	
			N°	Ø (mm)
32	140	100	4	18
40	150	110		
50	165	125		
65	185	145		
80	200	160	8	18
100	220	180		
125	250	210		

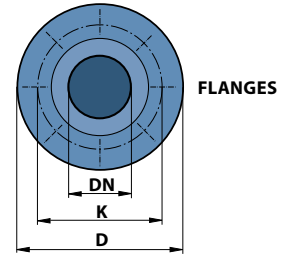

MODEL	PORTS		DIMENSIONS mm														kg	
	DN1	DN2	a	f	h1	h2	b	m1	m2	n1	n2	s1	s2	w	x	d		l
FG 32/160	50	32	80	360	132	160	50	100	95	70	240	190	14	260	100	24	50	32
FG 32/200					160	180	55	245			35							
FG 32/200H					160	180	55	245	35									
FG 40/160	65	40	100	360	132	160	50	100	100	70	240		14	260	100	24	50	35
FG 40/200					160	180	55	265			212	38						
FG 40/250					180	225	65	125	95	320	250	58						
FG 50/125	65	50	100	360	132	160	50	100	100	70	240	190	14	260	100	24	50	30
FG 50/160					160	180	55	265			212	35						
FG 50/200					160	200	50					45						
FG 50/250	180	225	65	125	95	320	250	50										
FG 65/125	80	65	100	360	160	180	65	125	125	95	280	212	14	260	100	24	50	42
FG 65/160					160	200	65											45
FG 65/200					180	225	65	320	250	50								
FG 65/250	470	200	250	80	160	120	360	280	18	340		32	80	71				
FG 80/160	100	80	125	360	180	225	65	125	125	95	320	250	14	260	140	24	50	48
FG 80/200					180	250	65	345			280	65						
FG 80/250					470	200	280	80	160	120	400	315						18
FG 100/160	125	100	140	360	200	280	80	160	160	120	360	280	18	260	140	24	50	55
FG 100/200					200	280	80	400			315	75						
FG 100/250					470	225	280	80	160	120	400	315						18

IMPELLERS TRIMMING

To reduce the performances of radial or semi-axial pumps, at the same speed of rotation, the outside diameter of the impeller should be reduced.

The trimming should be limited to the value where the impeller blades still overlap when we look at them radially.

The diagrams of pump characteristics usually show curves for several impeller diameters

To calculate the diameter reduction a rule of thumb can be applied; an exact calculation is not possible since the geometric similarity of the impeller blades is not preserved when trimming the impeller.

The impellers with conic exit width are trimmed on the blades as shown in the characteristic curves diagrams (as shown in Fig. 1).

The relationship between Q and H and the outside diameter (average if required) of the impeller is resumed in the following approximate equation (index 1=condition prior to the reduction in diameter, index 2=condition after reduction)

$$(\varnothing_1/\varnothing_2)^2 \approx Q_1/Q_2 \approx H_1/H_2 \quad \text{Equation (1)}$$

There follows:

$$\varnothing_2 \approx \varnothing_1 \cdot \sqrt{(Q_2/Q_1)} \approx \varnothing_1 \cdot \sqrt{(H_2/H_1)} \quad \text{Equation (2)}$$

The parameters required to determine the reduced diameter are found as shown in fig. 2.

After identifying the new P2 working point in the performance chart, draw a straight line between the origin (Q = 0 and H = 0) and this point to intersect at a P1 point the available performance curve at diameter \varnothing_1 .

Therefore the values Q and H with index 1 and 2 can be found and then used with Equation 2 to determine the new trimming diameter \varnothing_2 .

CAREFUL: after turning down impeller, calculate the new input power using the following equation

$$N = (Q \cdot H \cdot \gamma) / (367 \cdot \eta / 100)$$

Nomenclature:

N = power in kW

Q = flow rate in m³/h

H = total head in m

γ = density in kg/dm³

η = pump efficiency

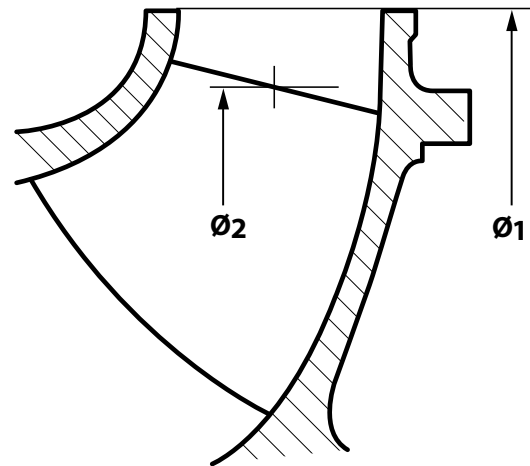

Fig. 1: Contour for cutting back the vanes of an impeller with a mixed flow exit

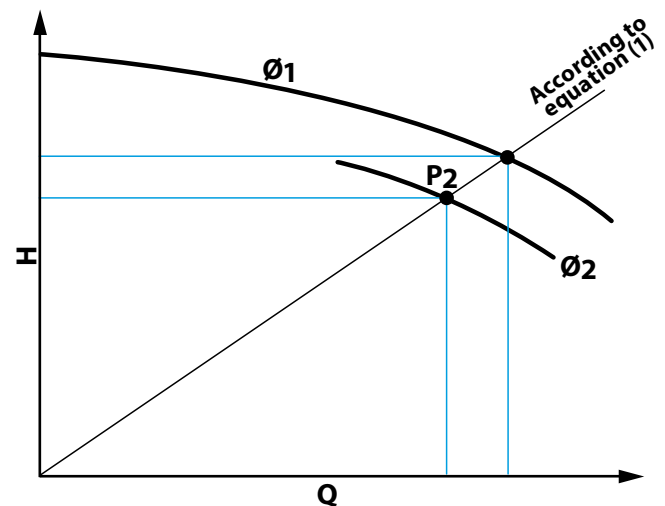
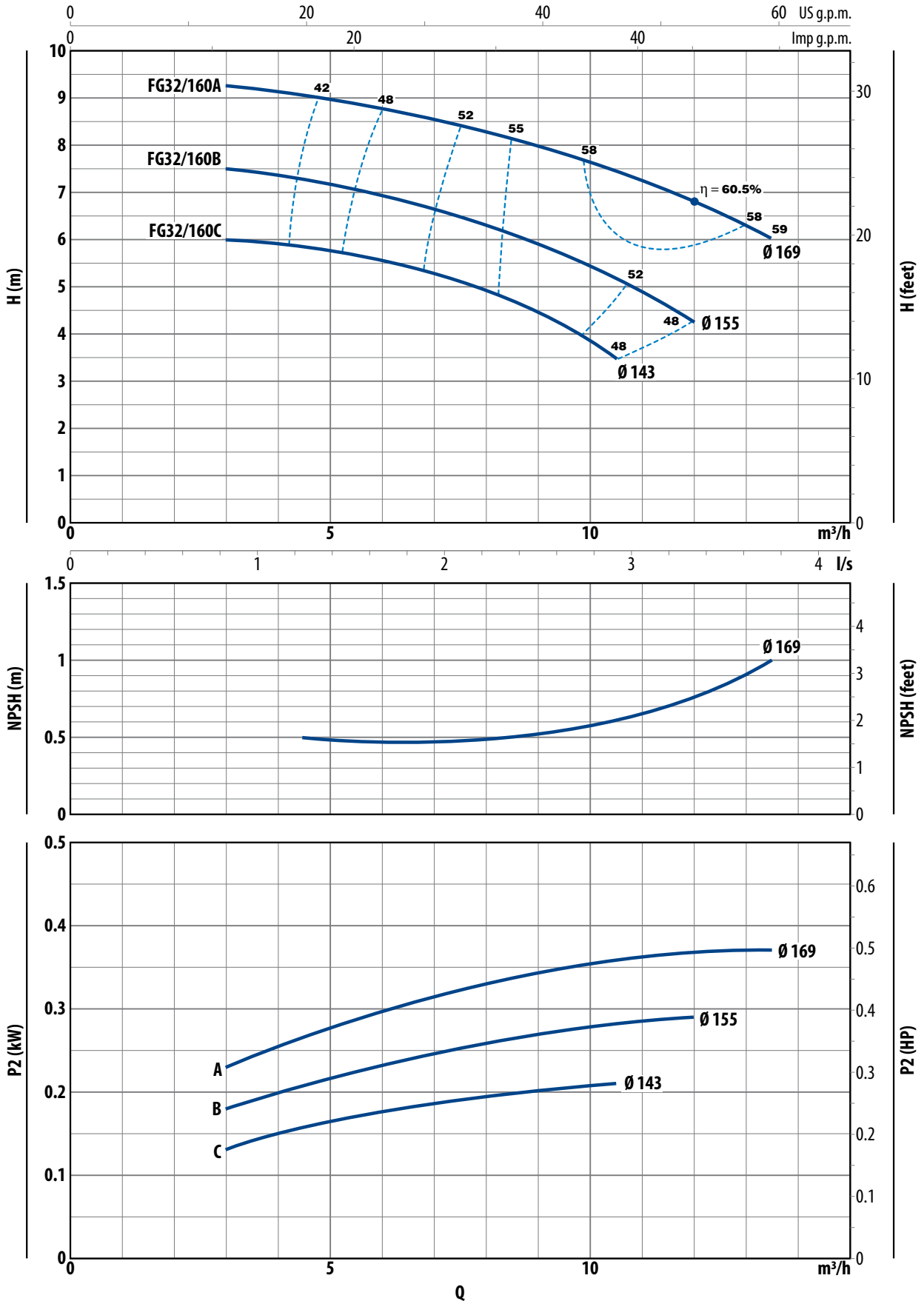

Fig. 2: Determination of the reduced impeller diameter \varnothing_2

FG32/160

CHARACTERISTIC CURVES

n= 1450 1/min 4 Pole 50 Hz HS= 0 m



CHARACTERISTIC CURVES

n= 1450 1/min 4 Pole 50 Hz HS= 0 m

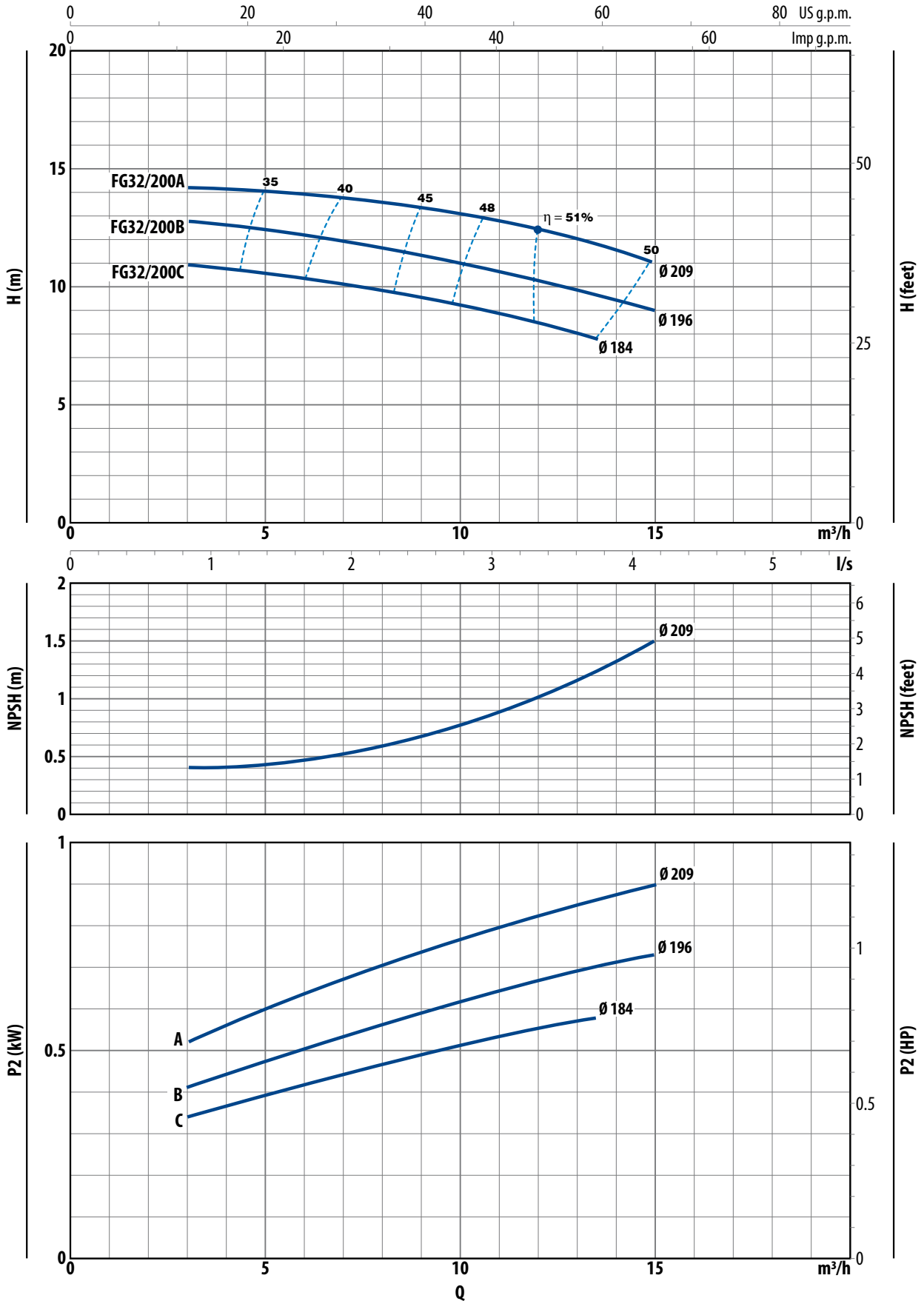

FG32/200H

CHARACTERISTIC CURVES

n= 1450 1/min 4 Pole 50 Hz HS= 0 m

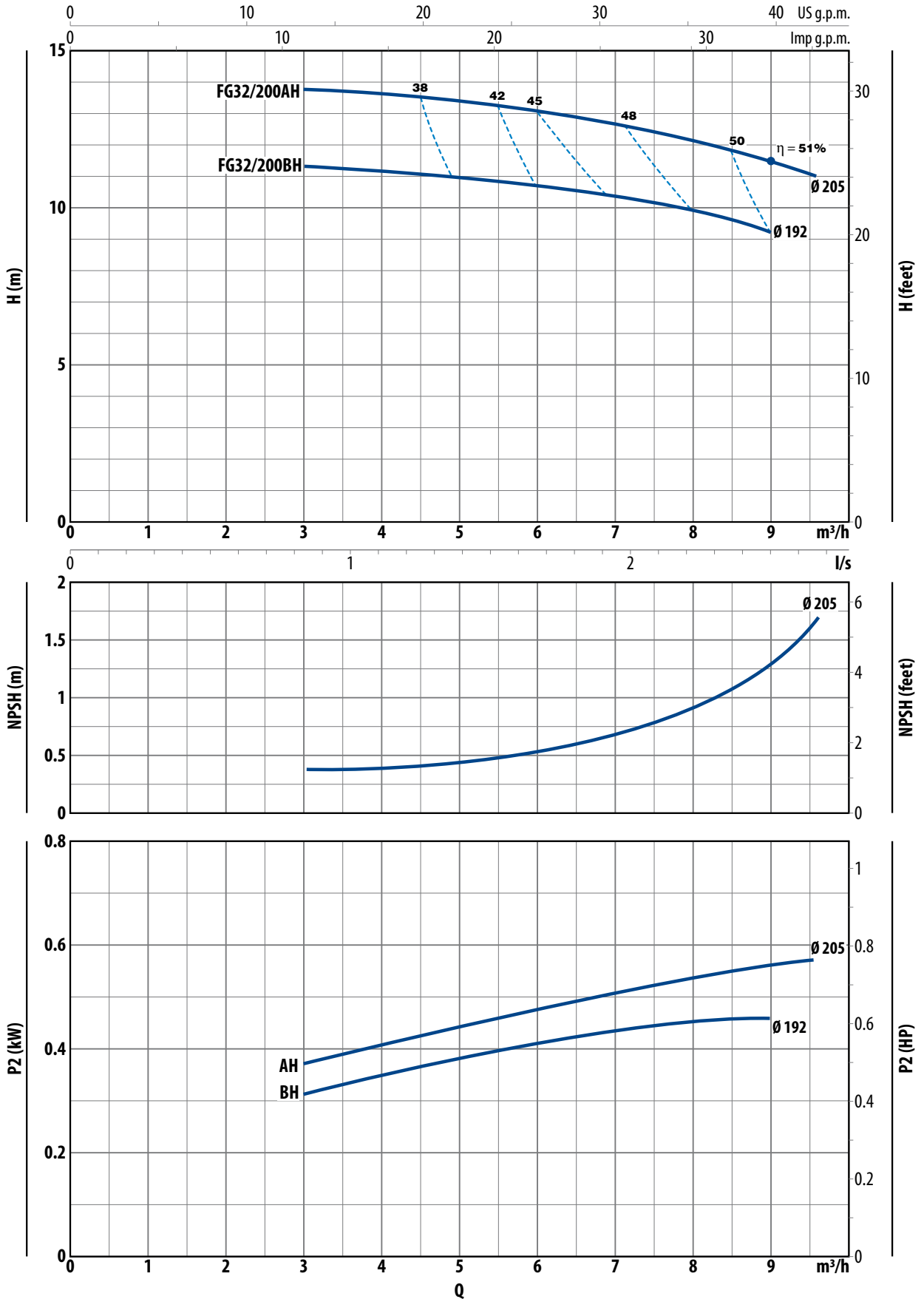

CHARACTERISTIC CURVES

n= 1450 1/min 4 Pole 50 Hz HS= 0 m

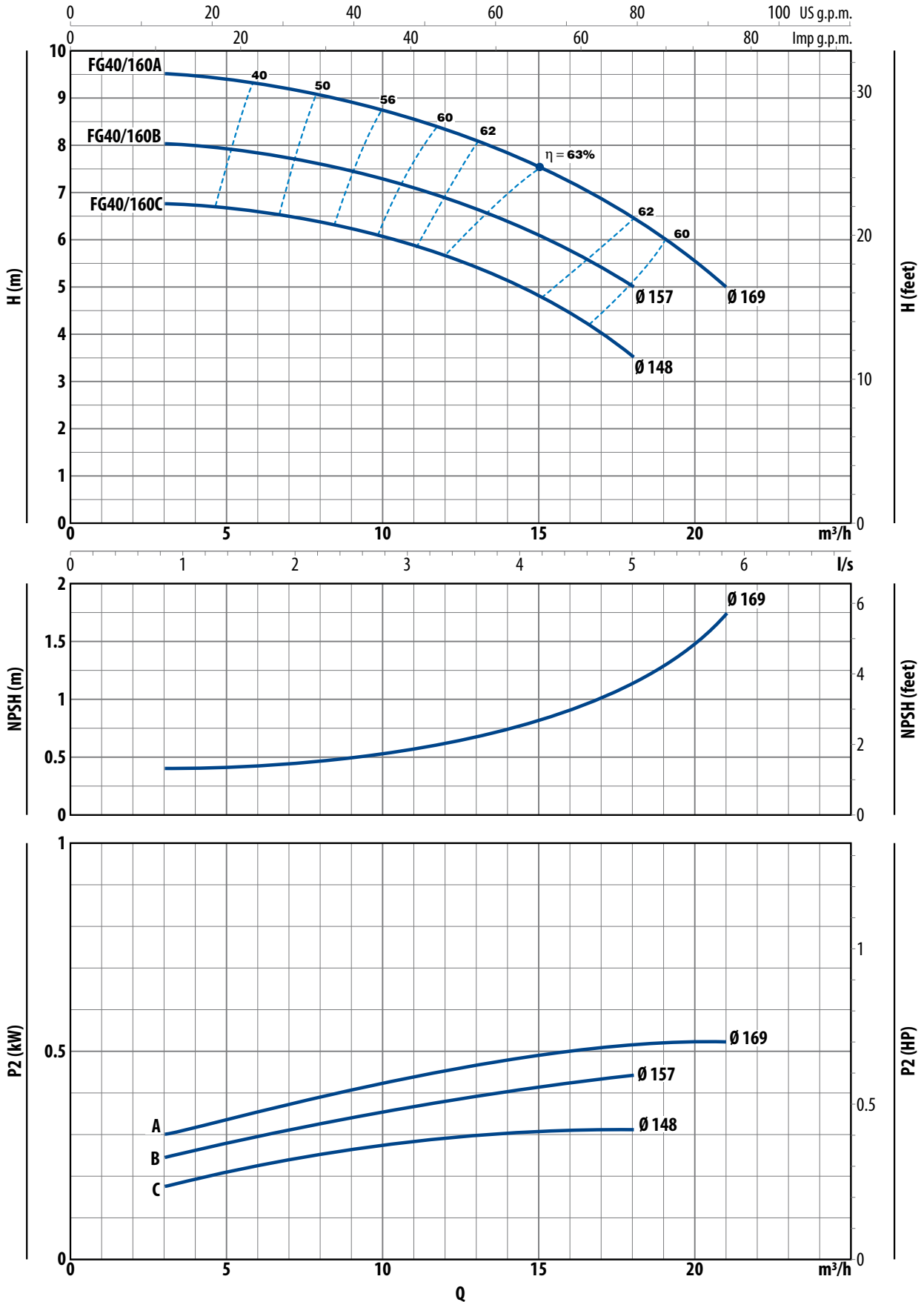

FG40/200

CHARACTERISTIC CURVES

n= 1450 1/min 4 Pole 50 Hz HS= 0 m

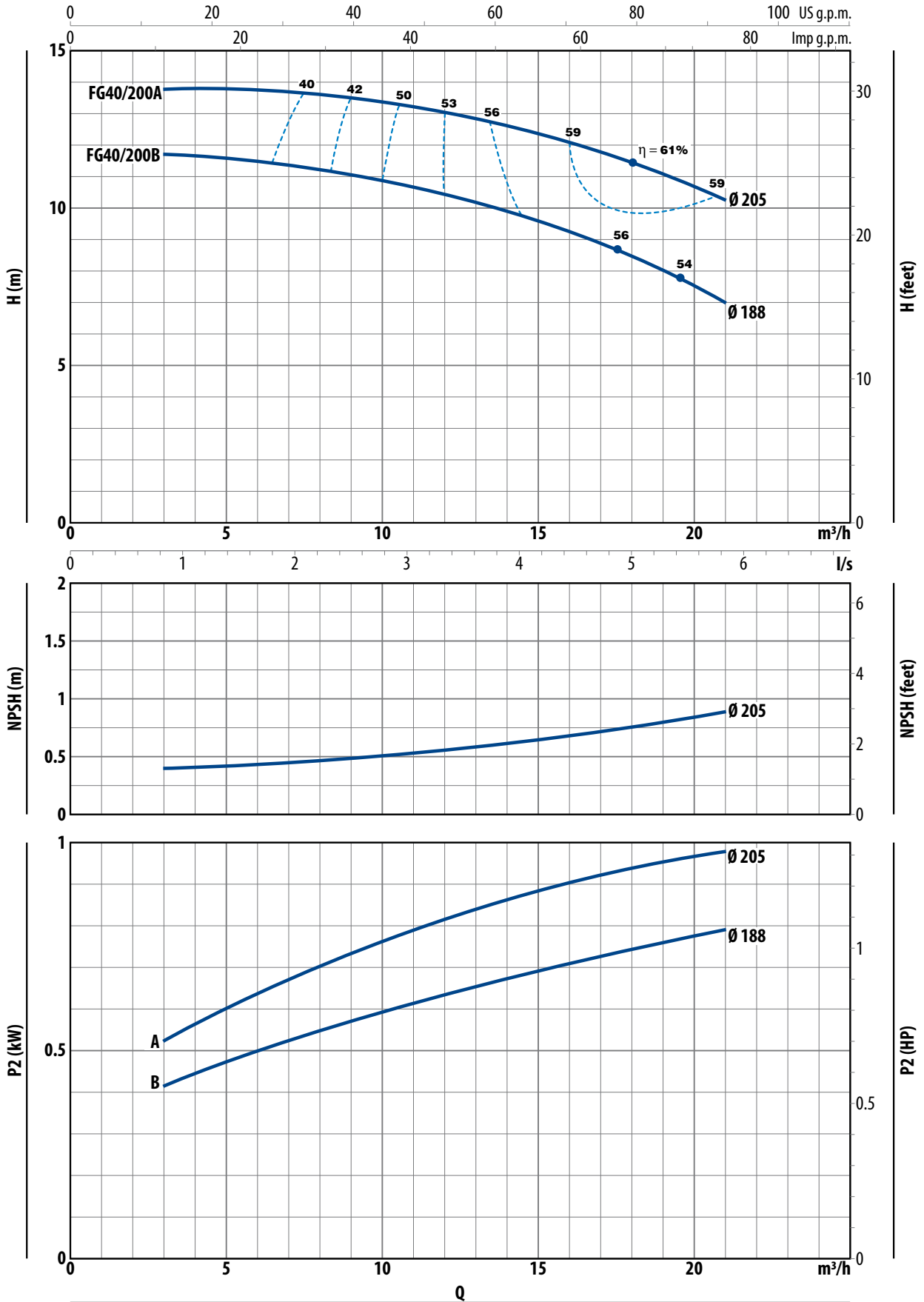

CHARACTERISTIC CURVES

n= 1450 1/min 4 Pole 50 Hz HS= 0 m

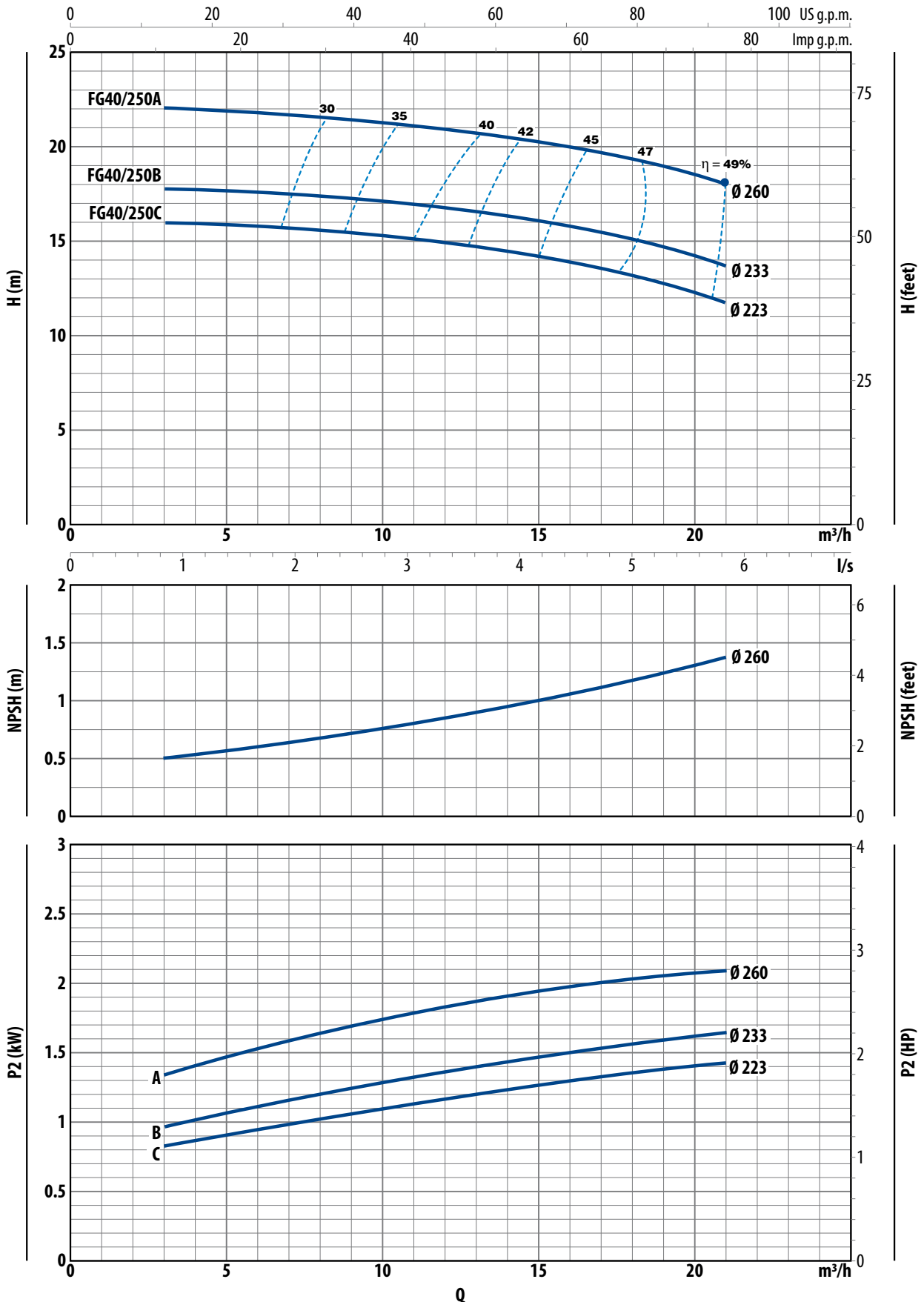

FG50/125

CHARACTERISTIC CURVES

n= 1450 1/min 4 Pole 50 Hz HS= 0 m

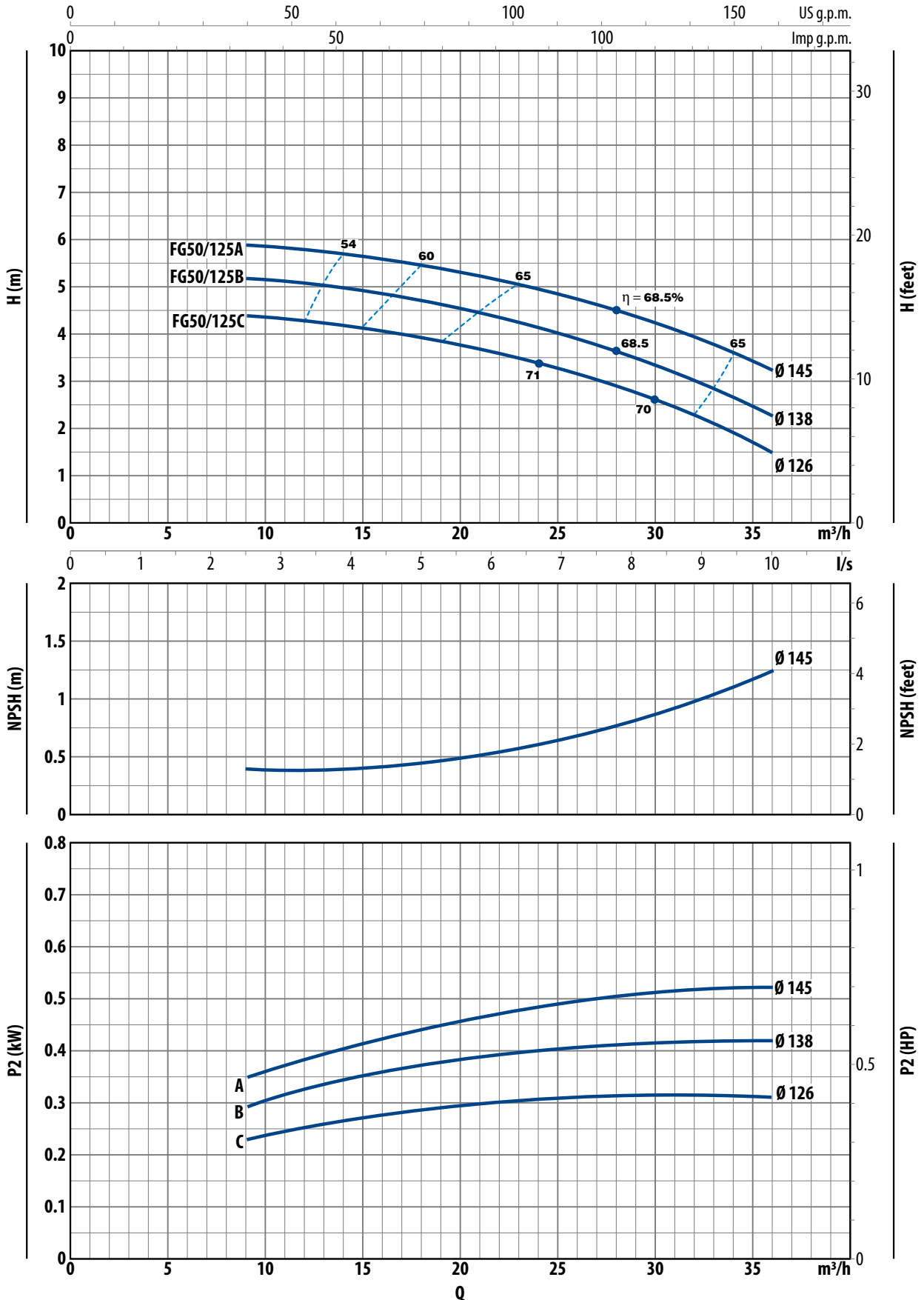

CHARACTERISTIC CURVES

n= 1450 1/min 4 Pole 50 Hz HS= 0 m

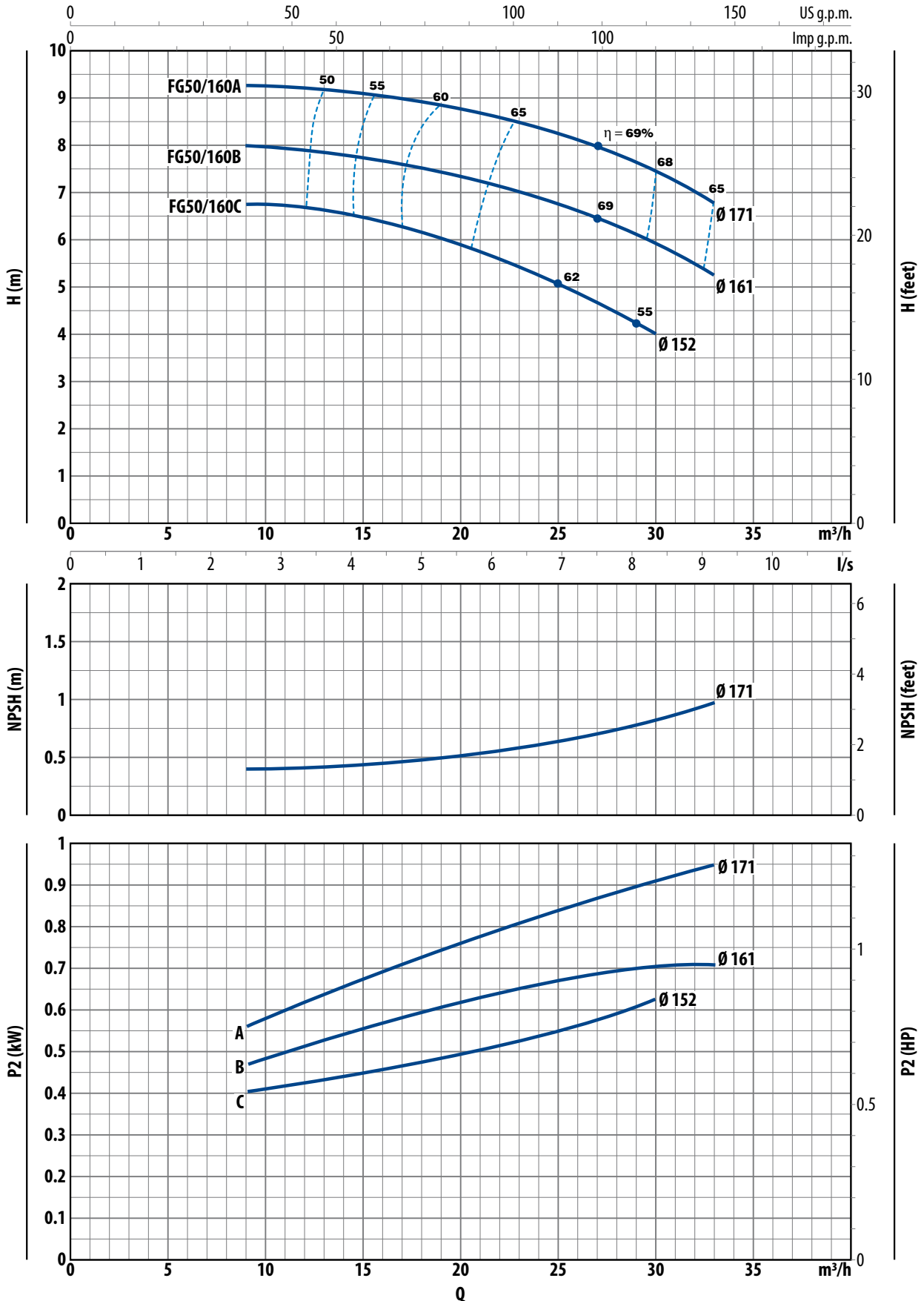

FG50/200

CHARACTERISTIC CURVES

n= 1450 1/min 4 Pole 50 Hz HS= 0 m

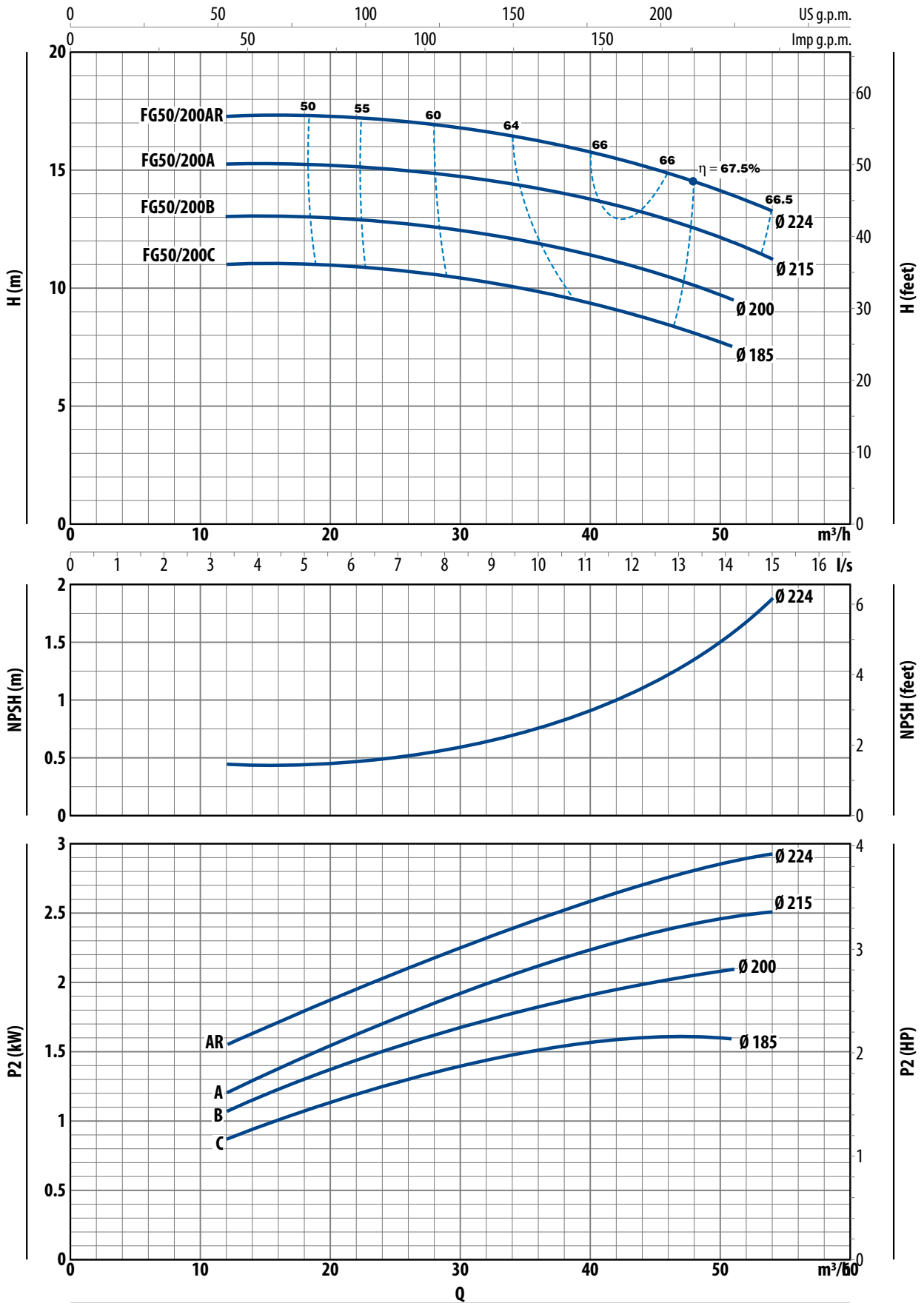

CHARACTERISTIC CURVES

n= 1450 1/min 4 Pole 50 Hz HS= 0 m

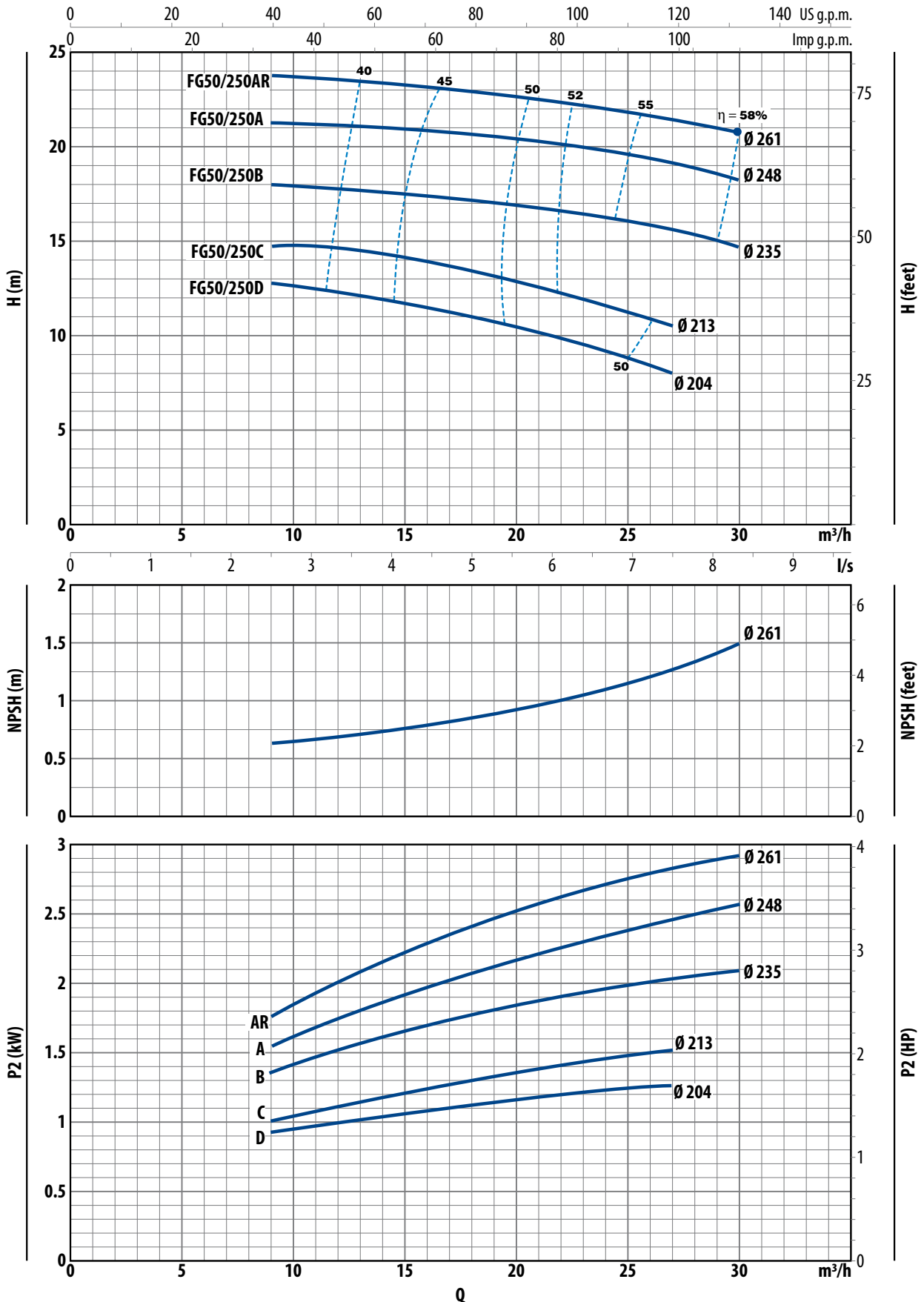

FG65/125

CHARACTERISTIC CURVES

n= 1450 1/min 4 Pole 50 Hz HS= 0 m

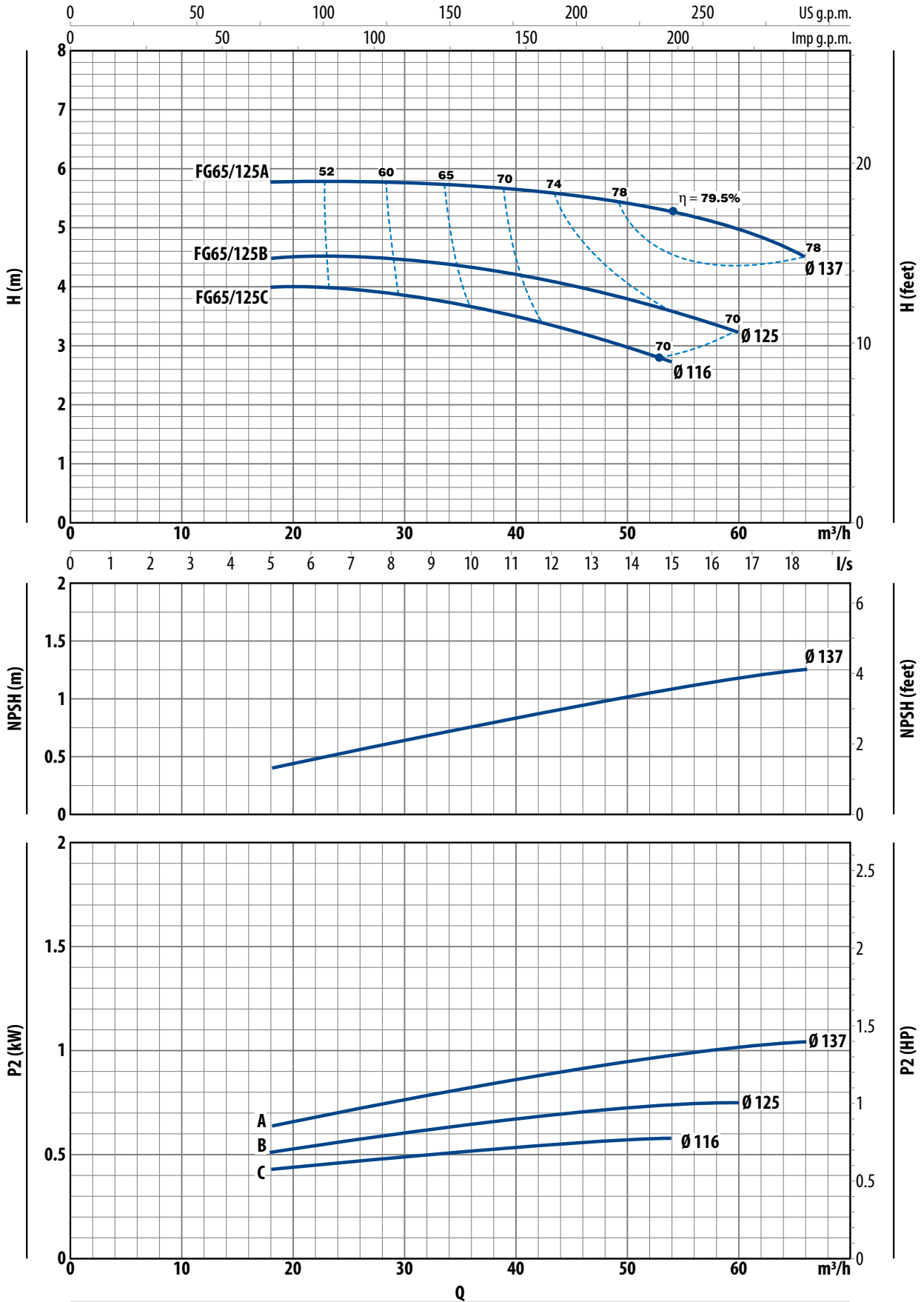

CHARACTERISTIC CURVES

n= 1450 1/min 4 Pole 50 Hz HS= 0 m

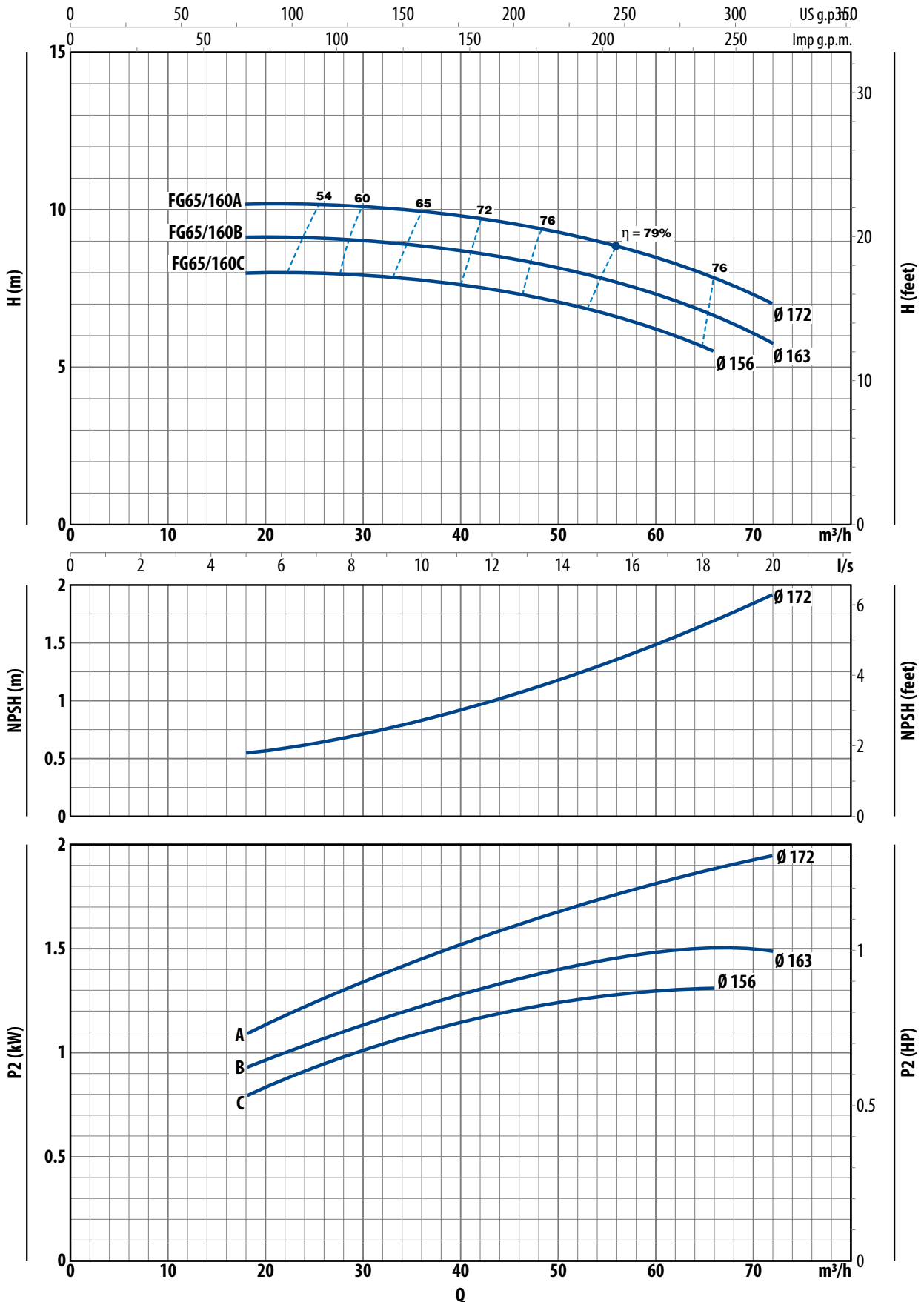

FG65/200

CHARACTERISTIC CURVES

n= 1450 1/min 4 Pole 50 Hz HS= 0 m

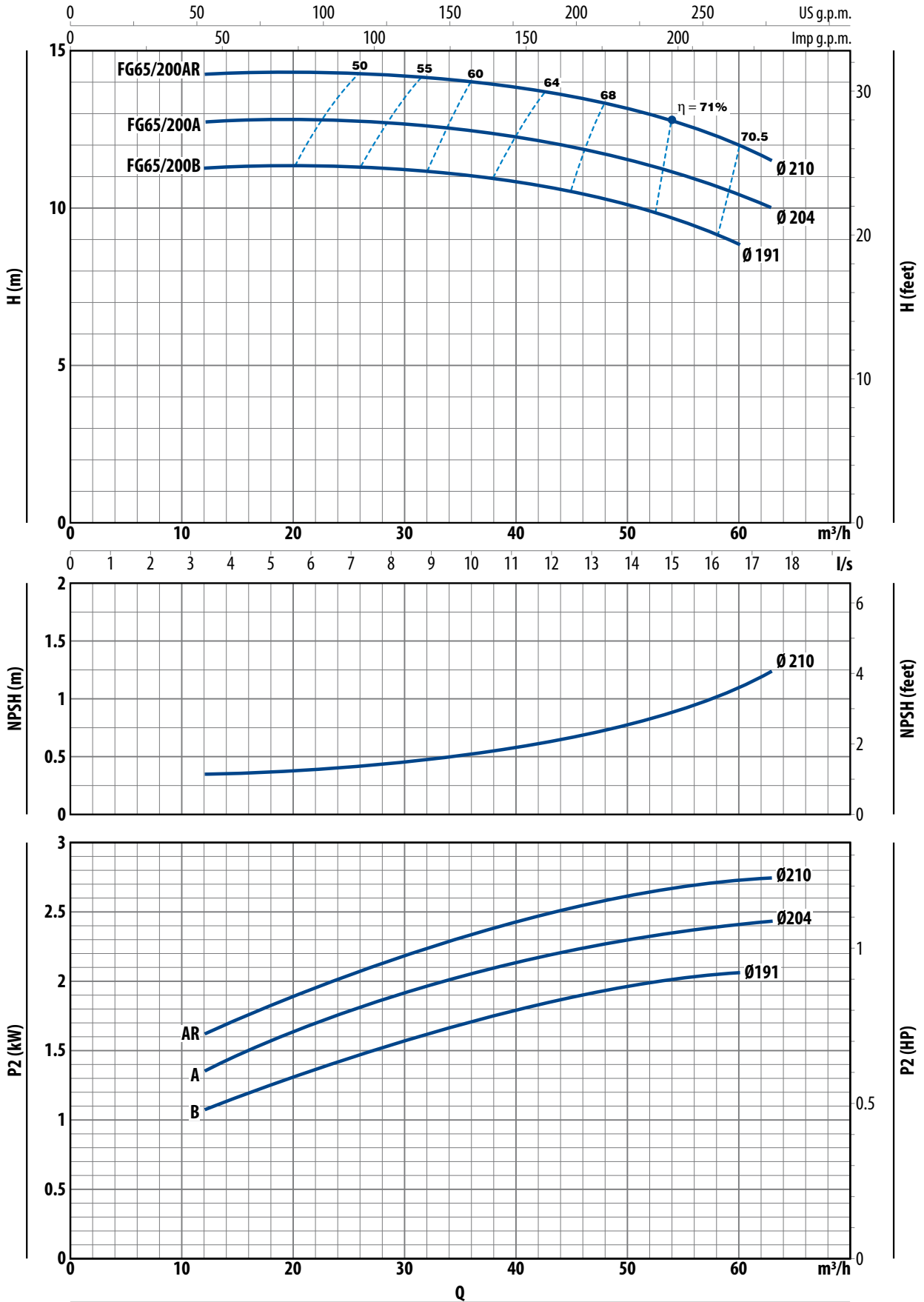

CHARACTERISTIC CURVES

n= 1450 1/min 4 Pole 50 Hz HS= 0 m

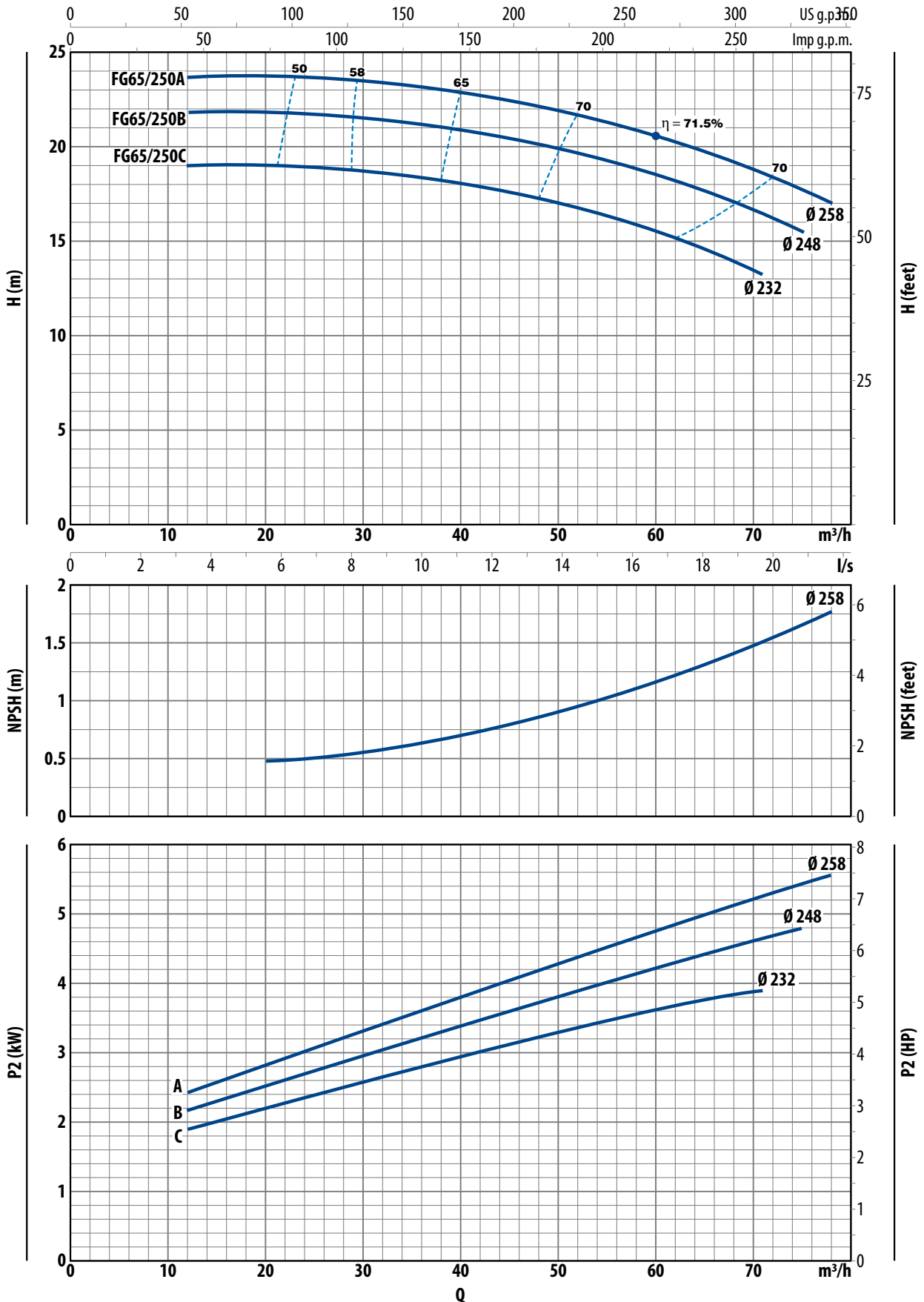

FG80/160

CHARACTERISTIC CURVES

n= 1450 1/min 4 Pole 50 Hz HS= 0 m

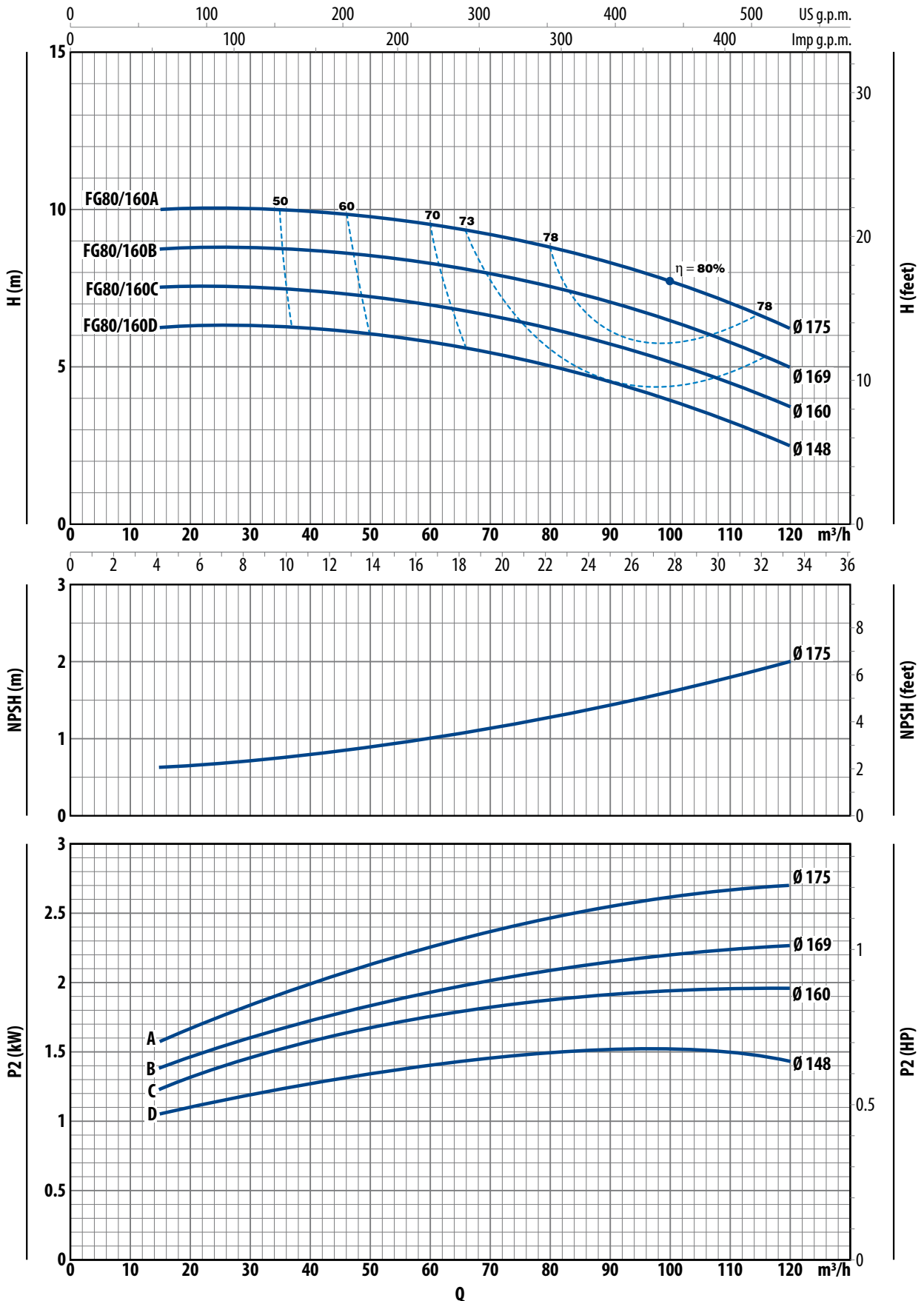

CHARACTERISTIC CURVES

n= 1450 1/min 4 Pole 50 Hz HS= 0 m

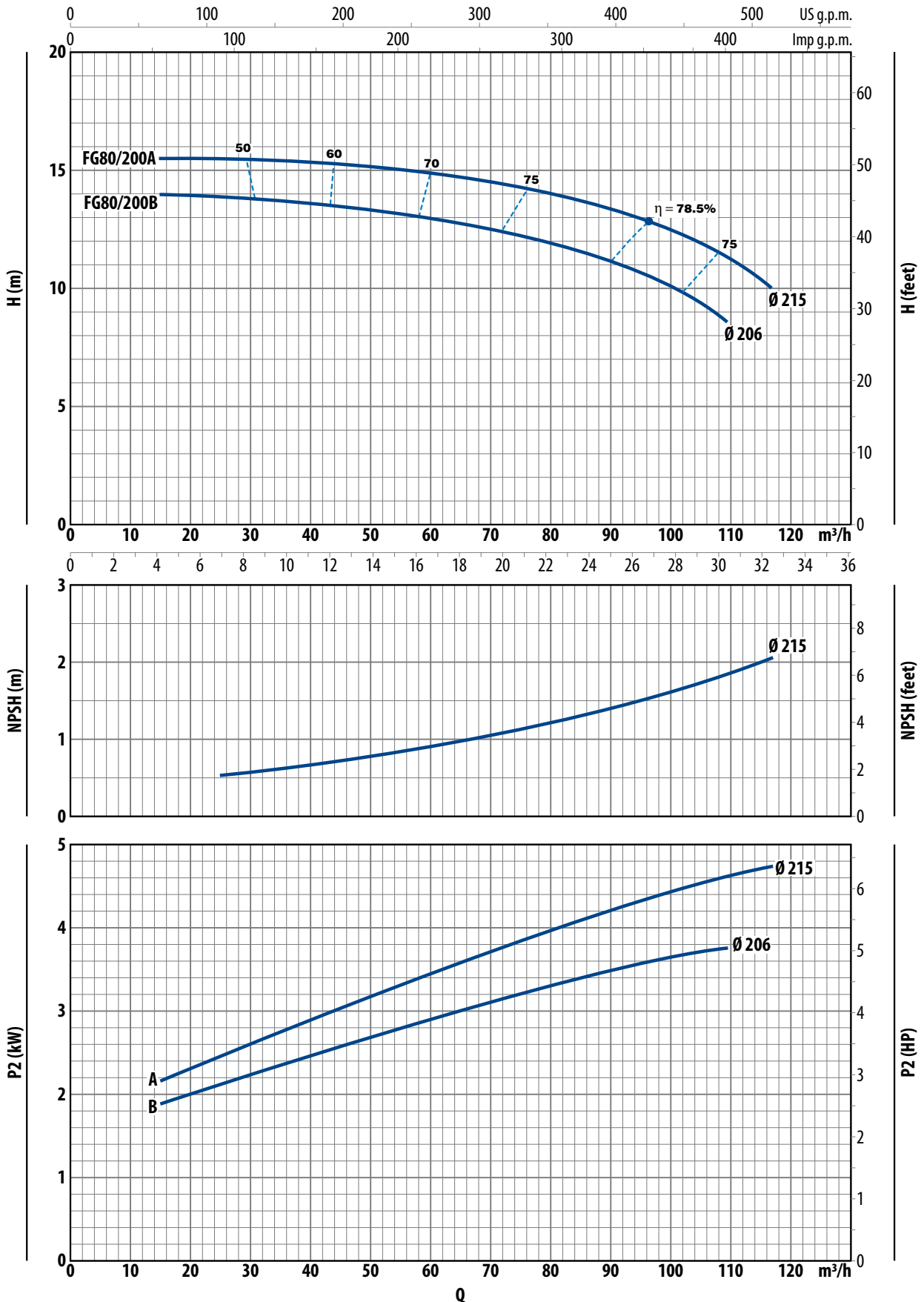

FG80/250

CHARACTERISTIC CURVES

n= 1450 1/min 4 Pole 50 Hz HS= 0 m

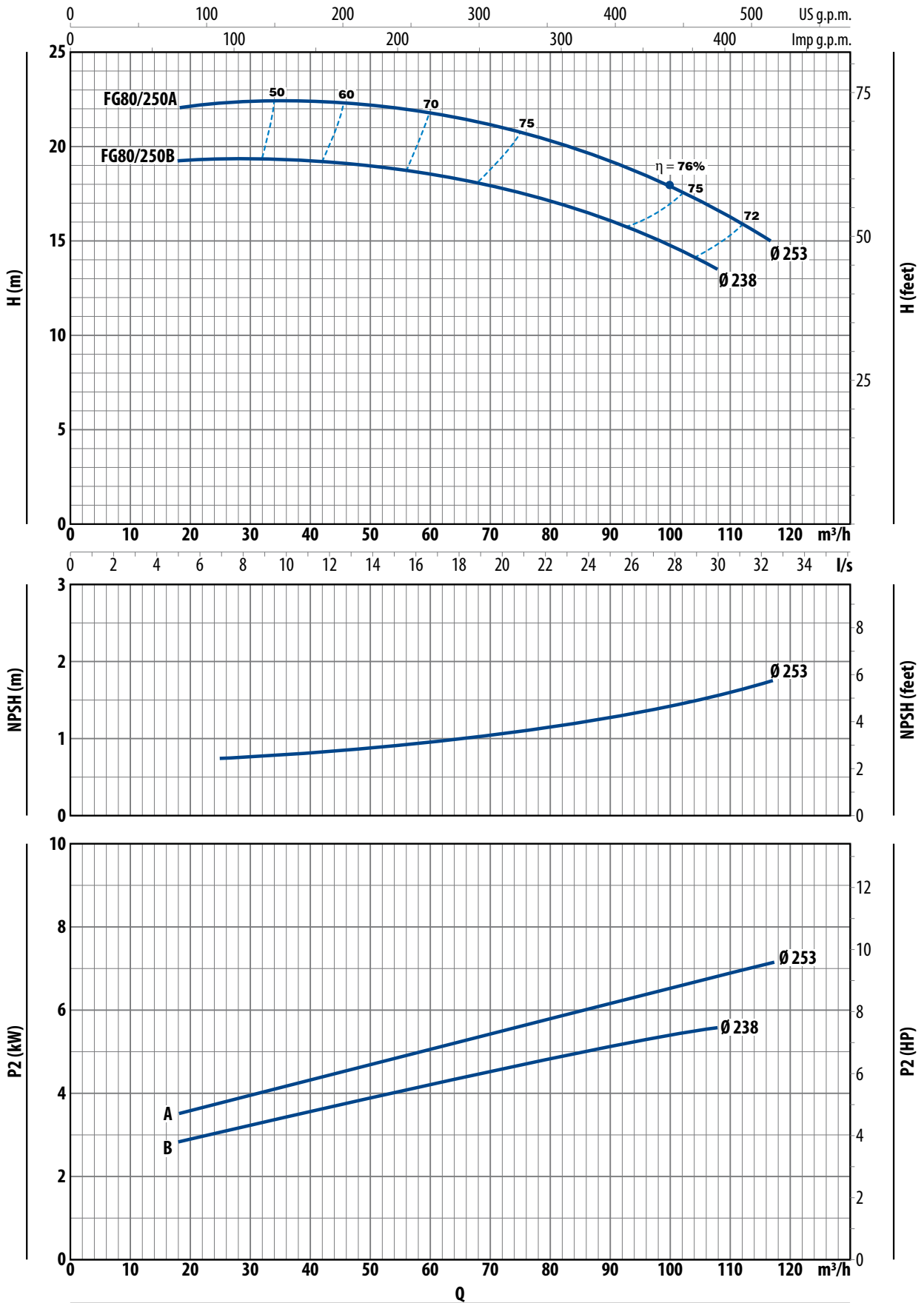

CHARACTERISTIC CURVES

n = 1450 1/min 4 Pole 50 Hz HS = 0 m

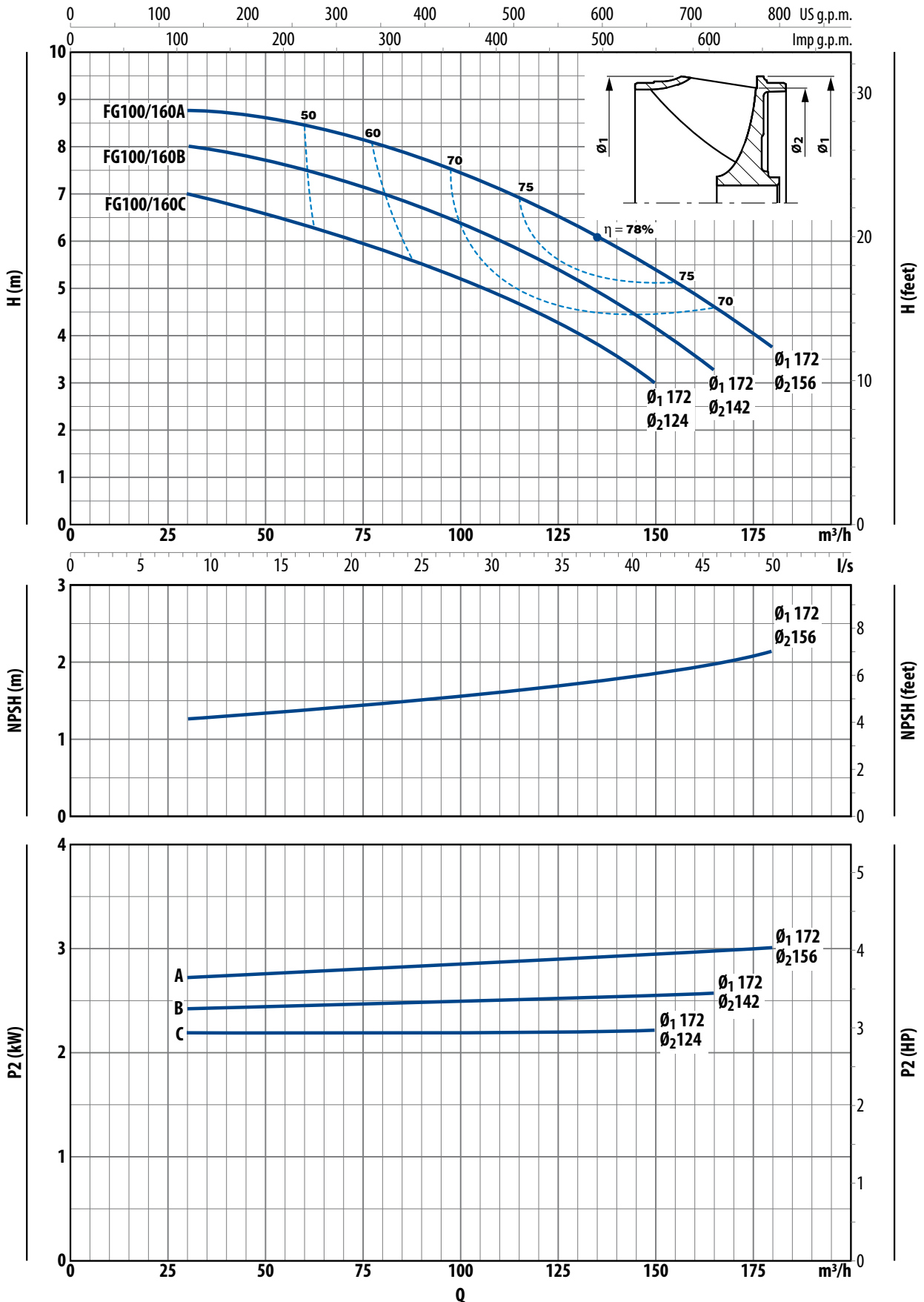

FG 100/200

CHARACTERISTIC CURVES

n= 1450 1/min 4 Pole 50 Hz HS= 0 m

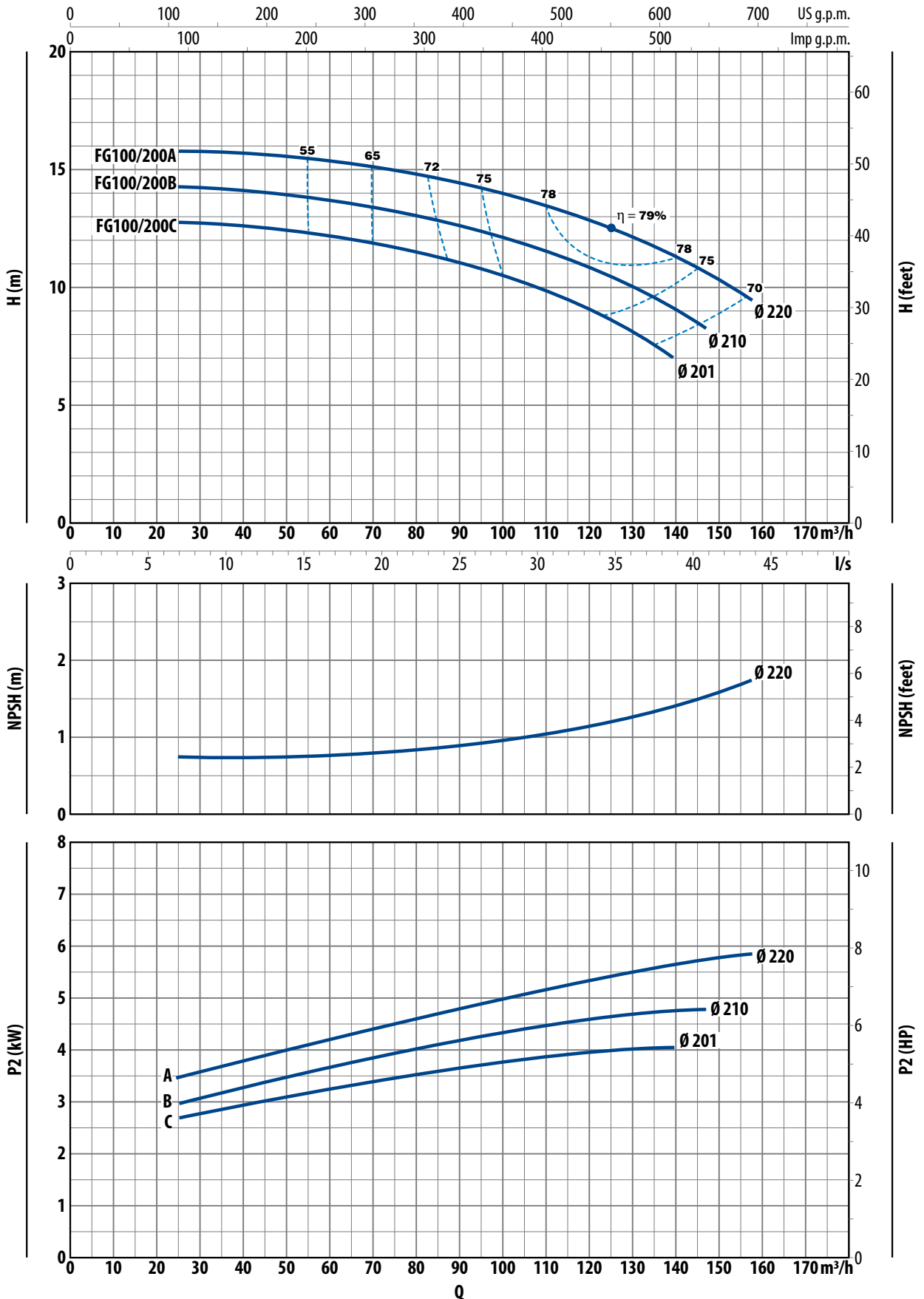

CHARACTERISTIC CURVES

n= 1450 1/min 4 Pole 50 Hz HS= 0 m

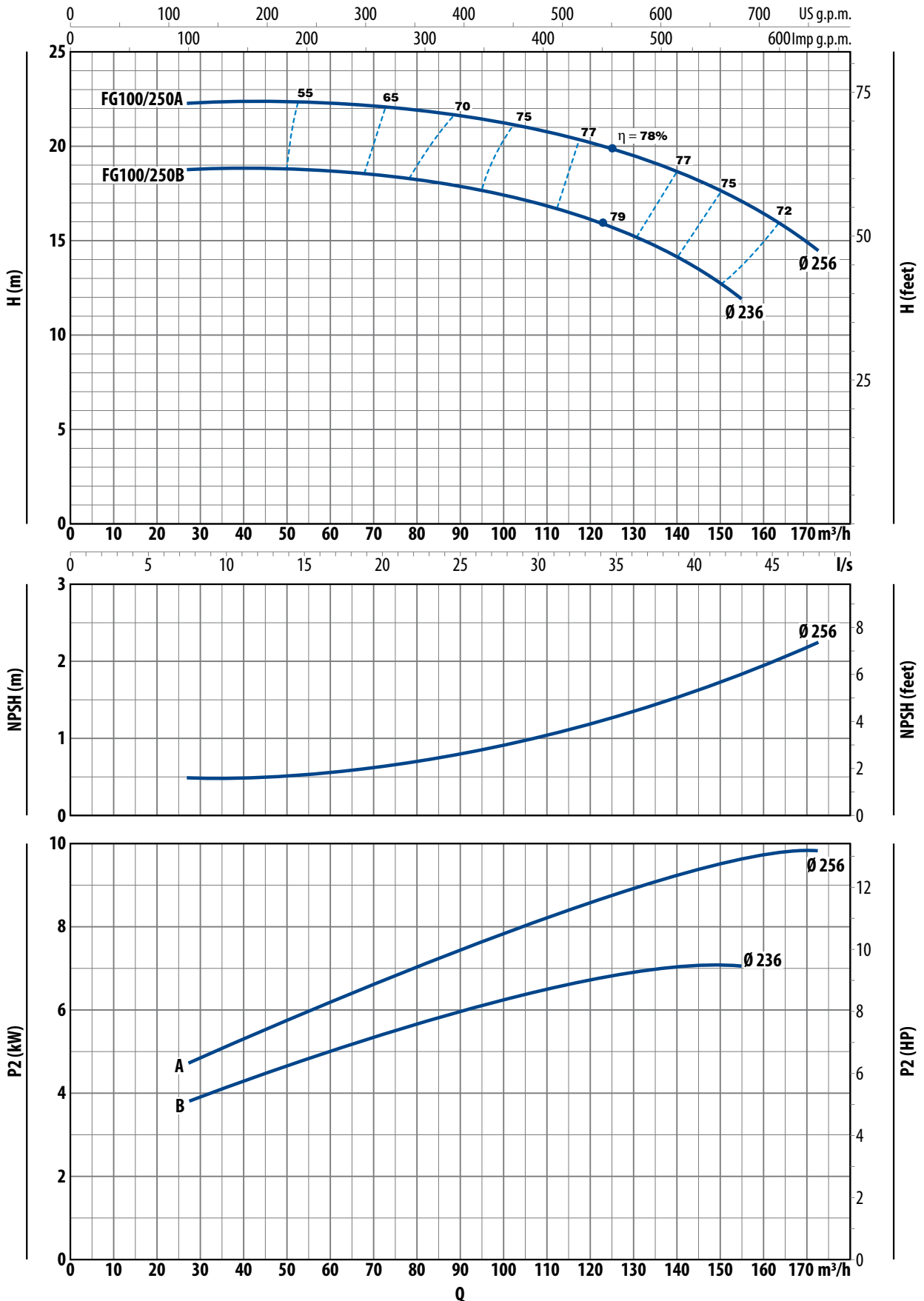

Notes

A series of 21 horizontal dotted lines for writing notes.



PEDROLLO SpA

Via Enrico Fermi 7 - 37047 San Bonifacio (VR) ITALY
tel. +39 045 6136311 - fax +39 045 7614663
sales@pedrollo.com - **www.pedrollo.com**